

 made in Italy

2014

Catalogo generale
General catalogue

EDILGRAPPA

macchinari e attrezzature
building, industry
per edilizia, industria e soccorso
& rescue tools

Catalogo generale

General catalogue

■	MACCHINE ELETTRICHE PORTATILI <i>HANDHELD ELECTRIC TOOLS</i>	3
	CESOIE A BATTERIA - <i>CORDLESS CUTTERS</i>	3
	CESOIE ELETTRICHE A TESTA FISSA - <i>FIXED HEAD ELECTRIC CUTTERS</i>	5
	MACCHINE PIEGATRICI A TESTA FISSA - <i>FIXED HEAD BENDING TOOLS</i>	9
	CORPI CESOIA A TESTA INTERCAMBIABILE - <i>INTERCHANGEABLE HEAD TOOL BODIES</i>	10
■	TESTE INTERCAMBIABILI <i>INTERCHANGEABLE HEADS</i>	11
■	PUNZONATRICI <i>PUNCHING TOOLS</i>	16
	PUNZONATRICI PORTATILI - <i>HANDHELD PUNCHING TOOLS</i>	16
	PUNZONATRICI IDRAULICHE - <i>HYDRAULIC PUNCHING TOOLS</i>	19
■	ATTREZZATURA IDRAULICA <i>HYDRAULIC TOOLS</i>	20
	CESOIE IDRAULICHE - <i>HYDRAULIC CUTTERS</i>	20
	TAGLIA CAVI - <i>CABLE CUTTERS</i>	22
	CESOIE IDRAULICHE A FORBICE - <i>SHEAR BLADES HYDRAULIC CUTTERS</i>	23
	RADDRIZZATORI - <i>STRAIGHTENING TOOLS</i>	25
	CENTRALINE IDRAULICHE - <i>HYDRAULIC PUMPS</i>	26
■	DEMOLIZIONE CONTROLLATA <i>CONCRETE CRUSHER</i>	29
	PINZE DEMOLITRICI PORTATILI - <i>HANDHELD CONCRETE CRUSHERS</i>	29
	PINZE DEMOLITRICI PER ESCAVATORE - <i>EXCAVATOR MOUNT CONCRETE CRUSHERS</i>	34
	CILINDRI SPACCAROCCIA - <i>ROCK SPLITTERS</i>	37
■	SOCCORSO - APPLICAZIONI U.S.A.R. <i>URBAN SEARCH AND RESCUE</i>	38
	ATTREZZATURA DI SOCCORSO U.S.A.R. - <i>U.S.A.R. RESCUE TOOLS</i>	38
■	ACCESSORI - <i>ACCESSORIES</i>	43

CESOIA PRO-CUT 12 A BATTERIA
PRO-CUT 12 CORDLESS CUTTER
COD. 1.50.2767



360° Testa girevole a 360°
 360° rotating head

Optional: impugnatura laterale
 side handle
 cod. 1.50.2542

VERSIONE CON INTERRUPTORE GENERALE
SPECIAL VERSION WITH MAIN SWITCH
COD. 1.50.2641

PRO-CUT 12 A BATTERIA	CORDLESS PRO-CUT 12	A BATTERIE PRO-CUT 12	BATTERIE PRO-CUT 12	1.50.2767
Taglio Ø	Cut Ø	Coupe Ø	Schneide Ø	12 mm R=70 Kg/mm ²
Tensione	Voltage	Tension	Spannung	18V
Potenza idraulica	Hydraulic power	Puissance hydraulique	Hydraulische Potenz	7 ton/280 bar
Peso con batteria al Litio	Weight including Lithium ion battery	Poids	Gewicht	kg 6,5
Dimensioni mm	Dimensions mm	Dimensions mm	Dimensionen mm	450x100x310

CESOIA MU16 A BATTERIA
MU16 CORDLESS CUTTER
COD. 1.50.2752

360° Testa girevole a 360°
 360° rotating head



Optional: impugnatura laterale
 side handle
 cod. 1.50.2542

Ideale per il taglio di rete elettrosaldata, barre tonde, catene, lucchetti ... in edilizia, industria e interventi di emergenza/ soccorso.

Suitable for cutting steel mesh, rebars, chains, locks ... main application fields are building and construction, industrial and rescue/emergency operations.

MU16 A BATTERIA	CORDLESS MU16	A BATTERIE MU16	BATTERIE MU16	1.50.2752
Taglio Ø	Cut Ø	Coupe Ø	Schneide Ø	16 mm R=70 Kg/mm ²
Tensione	Voltage	Tension	Spannung	18V
Potenza idraulica	Hydraulic power	Puissance hydraulique	Hydraulische Potenz	14 ton/560 bar
Peso con batteria al Litio	Weight including Lithium ion battery	Poids	Gewicht	kg 8,6
Dimensioni mm	Dimensions mm	Dimensions mm	Dimensionen mm	490x395x135

COD. 1.50.2750
CESOIA A BATTERIA SILVERCUT 20
SILVERCUT 20 CORDLESS CUTTER

COD. 1.50.2540
CESOIA A BATTERIA SILVERCUT 16
SILVERCUT 16 CORDLESS CUTTER



360° Testa girevole a 360°
360° rotating head

Taglio tondini fino al Ø 20 mm
Rebar cut up to Ø 20 mm



CESOIA	CUTTER	CISAILLE	SCHERE	SILVERCUT 20 1.50.2750	SILVERCUT 16 1.50.2540
Dimensioni	Dimensions	Dimensions	Dimensionen	500x320x100 mm	480x320x100 mm
Peso con batteria al Litio	Weight including Li-ion battery	Poids	Gewicht	9,4 kg	7,7 kg
Potenza idraulica	Hydraulic strength	Force hydraulique	Hydraulische Kraft	19 ton	11 ton
Taglio Ø	Cut Ø	Coupe Ø	Schneide Ø	20 mm R=70 Kg/mm ²	16 mm R=70 Kg/mm ²
Tensione	Voltage	Tension	Spannung	18V	18V
Pressione	Pressure	Pression	Druck	bar 550	bar 550

Tutte le macchine a batteria hanno una batteria al Litio in dotazione. Per batterie supplementari, carica batteria ed altri accessori vedi pag. 42

All cordless tools are supplied with one Lithium ion battery. For spare batteries, charger and other accessories see page 42

CESOIA PRO-CUT 12
PRO-CUT 12 CUTTER

COD. 1.50.1298

Impugnatura posteriore/lame a forbice
Rear handle/scissor blades

Modello certificato



Interruttore di sicurezza standard su tutta la gamma Edilgrappa; il rilascio provoca l'arresto immediato dell'alimentazione elettrica.

Standard safety switch on all Edilgrappa tools. When released the power supply stops immediately.

Optional: manico posteriore prolungato
rear extension handle
cod. 1.50.1364

impugnatura laterale
side handle
cod. 1.50.1914

CESOIA PRO-CUT 12	SHEAR PRO-CUT 12	CISAILLE PRO-CUT 12	SCHERE PRO-CUT 12	1.50.1298
Taglio Ø	Cut Ø	Coupe Ø	Schneide Ø	max 12mm R=70 Kg/mm ²
Potenza idraulica	Hydraulic power	Puissance hydraulique	Hydraulische Potenz	7 ton/280 bar
Potenza motore	Engine power	Moteur pouvoir	Potenz Motor	1200W/230V
Peso	Weight	Poids	Gewicht	kg 6,7
Dimensioni mm	Dimensions mm	Dimensions mm	Dimensionen mm	510x135x110

CESOIA PRO-CUT 12
PRO-CUT 12 CUTTER

COD. 1.50.1326

Impugnatura superiore/lame a forbice
Top handle/scissor blades



CESOIA PRO-CUT 12	SHEAR PRO-CUT 12	CISAILLE PRO-CUT 12	SCHERE PRO-CUT 12	1.50.1326
Taglio Ø	Cut Ø	Coupe Ø	Schneide Ø	max 12mm R=70 Kg/mm ²
Potenza idraulica	Hydraulic power	Puissance hydraulique	Hydraulische Potenz	7 ton/280 bar
Potenza motore	Motor power	Moteur pouvoir	Potenz Motor	1200W/230V
Peso	Weight	Poids	Gewicht	kg 6,7
Dimensioni mm	Dimensions mm	Dimensions mm	Dimensionen mm	420x210x110

CESOIA ELETTRICA MU16 TESTA FISSA
MU16 ELECTRIC CUTTER

COD. 1.50.1838

Modello certificato



Optional: manico posteriore prolungato
rear extension handle
cod. 1.50.1364

impugnatura laterale
side handle
cod. 1.50.1914

CESOIA ELETTRICA	ELECTRIC SHEAR	CISAILLE ÉLECTRIQUE	ELEKTRISCHE SCHERE	1.50.1838
Ø max	Ø max	Ø max	Ø max	16 mm R=70 Kg/mm ²
Tensione	Voltage	Tension	Spannung	230V/50Hz
Watt	Watt	Watt	Watt	1100
Potenza idraulica	Hydraulic power	Puissance hydraulique	Hydraulische Potenz	14 ton/560 bar
Peso	Weight	Poids	Gewicht	9,1 kg
Dimensioni mm	Dimensions mm	Dimensions mm	Dimensionen mm	520x120x130

CESOIA ELETTRICA MU18
MU18 ELECTRIC CUTTER
COD. 1.50.689



CESOIA ELETTRICA	ELECTRIC SHEAR	CISAILLE ÉLECTRIQUE	ELEKTRISCHE SCHERE	1.50.689
Taglio Ø	Cut Ø	Coupe Ø	Schneide Ø	Max 18 mm R=70 Kg/mm ²
Tensione	Voltage	Tension	Spannung	230V/50Hz
Watt	Watt	Watt	Watt	1100
Potenza idraulica	Hydraulic power	Puissance hydraulique	Hydraulische Potenz	14 ton/560 bar
Peso	Weight	Poids	Gewicht	9 kg
Dimensioni mm	Dimensions mm	Dimensions mm	Dimensionen mm	400x120x240

CESOIA ELETTRICA T22N
T22N ELECTRIC CUTTER
COD. 1.50.1265



CESOIA ELETTRICA	ELECTRIC SHEAR	CISAILLE ÉLECTRIQUE	ELEKTRISCHE SCHERE	1.50.1265
Taglio Ø	Cut Ø	Coupe Ø	Schneide Ø	Max 22 mm R=70 Kg/mm ²
Tensione	Voltage	Tension	Spannung	230V/50Hz
Watt	Watt	Watt	Watt	1150
Potenza idraulica	Hydraulic power	Puissance hydraulique	Hydraulische Potenz	22 ton/570 bar
Peso	Weight	Poids	Gewicht	13 kg
Dimensioni mm	Dimensions mm	Dimensions mm	Dimensionen mm	450x140x235

CESOIA ELETTRICA
ELECTRIC CUTTER
T26N COD. 1.50.1873
T28N COD. 1.50.2016



CESOIA ELETTRICA	ELECTRIC SHEAR	CISAILLE ÉLECTRIQUE	ELEKTRISCHE SCHERE	1.50.1873	1.50.2016
Taglio Ø	Cut Ø	Coupe Ø	Schneide Ø	Max 26 mm R=70 Kg/mm ²	Max 28 mm R=70 Kg/mm ²
Tensione	Voltage	Tension	Spannung	230V/50Hz	230V/50Hz
Watt	Watt	Watt	Watt	1150	1150
Potenza idraulica	Hydraulic power	Puissance hydraulique	Hydraulische Potenz	32 ton/580 bar	41 ton/650 bar
Peso	Weight	Poids	Gewicht	15,7 kg	16,9 kg
Dimensioni mm	Dimensions mm	Dimensions mm	Dimensionen mm	466x270x160	540x330x170

CESOIA ELETTRICA T32N
T32N ELECTRIC CUTTER
COD. 1.50.1916

Modello certificato  31704



CESOIA ELETTRICA	ELECTRIC SHEAR	CISAILLE ÉLECTRIQUE	ELEKTRISCHE SCHERE	1.50.1916
Taglio Ø	Cut Ø	Coupe Ø	Schneide Ø	Max 32 mm R=70 Kg/mm ²
Tensione	Voltage	Tension	Spannung	230V/50Hz
Watt	Watt	Watt	Watt	1150
Potenza idraulica	Hydraulic power	Puissance hydraulique	Hydraulische Potenz	46 ton/650 bar
Peso	Weight	Poids	Gewicht	27 kg
Dimensioni mm	Dimensions mm	Dimensions mm	Dimensionen mm	560x335x180

CESOIA ELETTRICA TW19 TAGLIO TREFOLO
TW19 ELECTRIC STRAND CUTTER
COD. 1.50.127



CESOIA ELETTRICA	ELECTRIC SHEAR	CISAILLE ÉLECTRIQUE	ELEKTRISCHE SCHERE	1.50.127
Taglio Ø	Cut Ø	Coupe Ø	Schneide Ø	Trefolo - Strand Max 16 mm
Tensione	Voltage	Tension	Spannung	230V/50Hz
Watt	Watt	Watt	Watt	1150
Potenza idraulica	Hydraulic power	Puissance hydraulique	Hydraulische Potenz	25 ton/570 bar
Peso	Weight	Poids	Gewicht	15,9 kg
Dimensioni mm	Dimensions mm	Dimensions mm	Dimensionen mm	480x140x235

CESOIA TAGLIA FUNI TF 32 DE
ROPE CUTTER TF 32 DE
COD. 1.50.2069



TAGLIA FUNI	ROPE CUTTER	TÊTE COUPE BRIN	STAHLSEIL SCHNEID KOPF	1.50.2069
Potenza idraulica	Hydraulic power	Puissance hydraulique	Hydraulische Potenz	18 ton/550 bar
Potenza motore	Engine power	Moteur pouvoir	Potenz Motor	1200W/230V
Taglio Ø	Cut Ø	Coupe Ø	Schneide Ø	32 mm
Peso	Weight	Poids	Gewicht	15,2 kg
Dimensioni mm	Dimensions mm	Dimensions mm	Dimensionen mm	560x185x240

CESOIA TAGLIA CAVI TC 55F42 DE
CABLE CUTTER TC 55F42 DE
COD. 1.50.2064



TAGLIA CAVI	CABLE CUTTER	COUPE CABLE	KABEL SCHNEIDER	1.50.2064
Potenza idraulica	Hydraulic power	Puissance hydraulique	Hydraulische Potenz	31 ton/550 bar
Potenza motore	Engine power	Moteur pouvoir	Potenz Motor	1200W/230V
Taglio Ø	Cut Ø	Coupe Ø	Schneide Ø	55 mm
Peso	Weight	Poids	Gewicht	24,3 kg
Dimensioni mm	Dimensions mm	Dimensions mm	Dimensionen mm	600x185x240

CESOIA ELETTRICA TAGLIO PIATTO
FLAT BAR ELECTRIC CUTTER
TP 50 COD. 1.50.606
TP 70 COD. 1.50.598
TP 110 COD. 1.50.599



CESOIA ELETTRICA	ELECTRIC SHEAR	CISAILLE ÉLECTRIQUE	ELEKTRISCHE SCHERE	1.50.606	1.50.598	1.50.599
Taglio	Cut	Coupe	Schneide	50x17 mm	70x15 mm	110x10 mm
Tensione	Voltage	Tension	Spannung	230V/50Hz	230V/50Hz	230V/50Hz
Watt	Watt	Watt	Watt	1150	1150	1150
Giri	RPM	Tours	Touren	14.000/min	14.000/min	14.000/min
Potenza idraulica	Hydraulic power	Puissance hydraulique	Hydraulische Potenz	25 ton/570 bar	26 ton/600 bar	28 ton/640 bar
Peso	Weight	Poids	Gewicht	22 kg	27 kg	40 kg
Dimensioni mm	Dimensions mm	Dimensions mm	Dimensionen mm	500x140x250	550x150x250	570x250x250

CESOIA TAGLIA CATENA
CHAIN CUTTER
TC 26 COD. 1.50.1946
TC 32 DE COD. 1.50.1944



TAGLIA CATENA	CHAIN CUTTER	COUPE CHAINE	KETTEN SCHNEIDER	1.50.1946	1.50.1944
Taglio max Ø	Cut max Ø	Coupe max Ø	Schneide max Ø	26 (R=80 daN/mm ²)	32 (R=70 daN/mm ²)
Pressione	Pressure	Pression	Druck	550 bar	600 bar
Potenza idraulica	Hydraulic power	Puissance hydraulique	Hydraulische Potenz	31 ton	47 ton
Peso	Weight	Poids	Gewicht	24,7 kg	43 kg
Dimensioni mm	Dimensions mm	Dimensions mm	Dimensionen mm	610x240x165	700x300x165

MU16P - PER PIEGARE Ø 16
 MU16P - BENDING TOOL Ø 16
COD. 1.50.1100



CESOIA ELETTRICA	ELECTRIC SHEAR	CISAILLE ÉLECTRIQUE	ELEKTRISCHE SCHERE	1.50.1100
Ø max	Ø max	Ø max	Ø max	16 mm
Tensione	Voltage	Tension	Spannung	230V/50Hz
Watt	Watt	Watt	Watt	1100
Potenza idraulica	Hydraulic power	Puissance hydraulique	Hydraulische Potenz	10 ton/380 bar
Peso	Weight	Poids	Gewicht	12 kg
Dimensioni mm	Dimensions mm	Dimensions mm	Dimensionen mm	500x120x230

MACCHINA PIEGATRICE - RADDRIZZATRICE PR16-32
 PR16-32 BENDING - STRAIGHTENING TOOL
COD. 1.50.2631

COMPLETA DI BOCCOLE PER Ø 28÷32 mm
 FITTED WITH ROLLERS Ø 28÷32 mm



PIEGATRICE RADDRIZZATRICE	BENDING/STRAIGHTENING TOOL	PLIEUSE - REDRESSEUSE	BIEGE-RICHTE MASCHINE	1.50.2631
max Ø	max Ø	max Ø	max Ø	32 mm R=75 Kg/mm ²
Pressione	Pressure	Pression	Druck	550 bar
Potenza idraulica	Hydraulic power	Puissance hydraulique	Hydraulische Potenz	15,5 ton/550 bar ¹ 10,8 ton/550 bar ²
Peso	Weight	Poids	Gewicht	24,4 kg
Dimensioni mm	Dimensions mm	Dimensions mm	Dimensionen mm	610x298x229

¹ Spinta / Push - ² Trazione / Pull

Optional: boccia per piega Ø 22÷26 mm
 roller for bending Ø 22÷26 mm
cod. 1.10.6995

boccia per piega Ø 16÷20 mm
 roller for bending Ø 16÷20 mm
cod. 1.10.6996

CORPO CESOIA - MOTORE ELETTRICO
TOOL BODY - ELECTRIC MOTOR
MU 22N COD. 1.50.1952
MU 26N COD. 1.50.1891

Modelli certificati



BANCO PORTA CESOIA
TABLETOP FIXTURE
COD. 1.50.151

CORPO CESOIA	SHEAR FRAME	CORPS CISAILLE	SCHEREN GEHÄUSE	1.50.1952	1.50.1891
Taglio Ø	Cut Ø	Coupe Ø	Schneide Ø	max 22 mm	max 26 mm
Tensione	Voltage	Tension	Spannung	230V/50Hz	230V/50Hz
Giri	RPM	Tours	Touren	14.000/min	14.000/min
Watt	Watt	Watt	Watt	1150	1150
Potenza idraulica	Hydraulic power	Puissance hydraulique	Hydraulische Potenz	25 ton/570 bar	32 ton/580 bar
Peso	Weight	Poids	Gewicht	13,3 kg	11,5 kg
Dimensioni mm	Dimensions mm	Dimensions mm	Dimensionen mm	385x240x180	405x250x170

CORPO CESOIA - MOTORE A SCOPPIO
TOOL BODY - PETROL ENGINE
TPS 22N COD. 1.50.2057
TPS 26N COD. 1.50.2032



CORPO CESOIA	TOOL BODY	CORPS CISAILLE	SCHEREN GEHÄUSE	1.50.2057	1.50.2032
Taglio Ø	Cut Ø	Coupe Ø	Schneide Ø	max 22 mm	max 26 mm
Giri	RPM	Tours	Touren	14.000/min	14.000/min
Motore	Engine	Moteur	Motor	Hp 1,78	Hp 1,78
Potenza idraulica	Hydraulic power	Puissance hydraulique	Hydraulische Potenz	25 ton/570 bar	32 ton/580 bar
Peso	Weight	Poids	Gewicht	15 kg	15,2 kg
Dimensioni mm	Dimensions mm	Dimensions mm	Dimensionen mm	440x285x265	460x285x265

CORPO CESOIA DOPPIO EFFETTO - MOTORE ELETTRICO
DOUBLE ACTING TOOL BODY - ELECTRIC MOTOR
MU 26 DE COD. 1.50.149

VERSIONE CON MOTORE A SCOPPIO
PETROL ENGINE VERSION
TPS 26 DE COD. 1.50.150



CORPO CESOIA	TOOL BODY	CORPS CISAILLE	SCHEREN GEHÄUSE	1.50.149	1.50.150
Taglio Ø	Cut Ø	Coupe Ø	Schneide Ø	max 26 mm	max 26 mm
Tensione	Voltage	Tension	Spannung	230V/50Hz	Petrol engine
Giri	RPM	Tours	Touren	14.000/min	14.000/min
Motore	Motor	Moteur	Motor	1150W	Hp 1,78
Potenza idraulica	Hydraulic power	Puissance hydraulique	Hydraulische Potenz	40 ton/640 bar	40 ton/640 bar
Peso	Weight	Poids	Gewicht	15,7 kg	15,9 kg
Dimensioni mm	Dimensions mm	Dimensions mm	Dimensionen mm	450x240x190	460x285x265

TESTA TAGLIO T14
T14 CUTTING HEAD
COD. 1.50.116



TESTA TAGLIO T14	T14 HEAD	T14 TÊTE	SCHNEID KOPF T14	1.50.116
Taglio	Cut	Coupe	Schneide	Max Ø 14
Profondità lame	Blades depth	Profondeur lames	Messertiefe	38 mm
Peso	Weight	Poids	Gewicht	4,9 kg
Dimensioni mm	Dimensions mm	Dimensions mm	Dimensionen mm	230x110x110

TESTA TAGLIO
CUTTING HEAD
T22 COD. 1.50.117
T26 COD. 1.50.085



TESTA TAGLIO T22-T26	CUTTING HEAD T22-T26	TÊTE DE COUPE T22-T26	SCHNEID KOPF T22-T26	1.50.117	1.50.085
Taglio	Cut	Coupe	Schneide	Max Ø 22	Max Ø 26
Peso	Weight	Poids	Gewicht	3,4 kg	4,7 kg
Dimensioni mm	Dimensions mm	Dimensions mm	Dimensionen mm	135x112x118	145x125x127

TESTA PIEGA
BENDING HEAD
P22 COD. 1.50.1915
P26 COD. 1.50.1890



TESTA PIEGA P22	BENDING HEAD P22	TÊTE DE PLIE P22	BIEGE KOPF P22	1.50.1915	1.50.1890
Tondo	Round steel bar	Rond a beton	Rundeisen für Beton	Max Ø 22	Max Ø 26
Peso	Weight	Poids	Gewicht	5,3 kg	7,6 kg
Dimensioni mm	Dimensions mm	Dimensions mm	Dimensionen mm	193x90x110	225x135x135

**TESTE INTERCAMBIABILI
INTERCHANGEABLE HEADS**



**TESTA TAGLIA SASSI TS500
STONE CUTTING HEAD TS500
COD. 1.50.106**

COD. 1.50.673
versione maggiorata indicata per tufo e blocchi in calcestruzzo
oversized model suitable for tuff stone and concrete building blocks

TESTA TS500	STONE CUTTING HEAD TS500	TÊTE COUPE PIERRE TS500	STEIN BRECHER KOPF TS500	1.50.106	1.50.673
Largh. taglio	Width cut	Larg. coupe	Schneidbreite	520 mm	520 mm
Altezza di taglio	Cutting height	Hauteur coupe	Höhe	215 mm	320 mm
Peso	Weight	Poids	Gewicht	153 kg	157 kg
Dimensioni mm	Dimensions mm	Dimensions mm	Dimensionen mm	1090x400x1135	1090x400x1260

**TESTA TAGLIO TREFOLO TW19
TW19 STRAND CUTTING HEAD
COD. 1.50.118**



TESTA TAGLIA TREFOLO	STRANDS CUTTING HEAD	TÊTE COUPE BRIN	LITZE SCHNEID KOPF	1.50.118
Taglio	Cut	Coupe	Schneide	Max 16 mm
Peso	Weight	Poids	Gewicht	3,6 kg
Dimensioni mm	Dimensions mm	Dimensions mm	Dimensionen mm	140x110x120

**TESTA TAGLIA FUNI/CAVI
ROPE/CABLE CUTTING HEAD
TF32 COD. 1.50.064
TF32DE COD. 1.50.679**



TESTA TAGLIA FUNI/CAVI	ROPE/CABLE CUTTING HEAD	TÊTE COUPE BRIN	STAHLSEIL SCHNEID KOPF	1.50.064 1.50.679
Taglio	Cut	Coupe	Schneide	Max 32 mm
Peso	Weight	Poids	Gewicht	4,5 kg
Dimensioni mm	Dimensions mm	Dimensions mm	Dimensionen mm	145x90x120

TESTA PER RADDRIZZARE TR40
TR40 STRAIGHTENING HEAD
COD. 1.50.061



Raggio di curvatura minimo su \varnothing 24: 330 mm
 Minimum bending radius on \varnothing 24: 330 mm

TESTA PER RADDRIZZARE	STRAIGHTENING HEAD	TÊTE POUR REDRESSER	RICHT KOPF	1.50.061
Tondo	Rod	Rond armé	Rundeisen	Max 30 mm
Peso	Weight	Poids	Gewicht	4,5 kg
Dimensioni mm	Dimensions mm	Dimensions mm	Dimensionen mm	270x150x90

TESTA ROMPI DADI RD26
RD26 NUT CRACKING HEAD
COD. 1.50.115



TESTA ROMPI DADI	NUT BREAK HEAD	TÊTE CASSE ÉCROU	SCHRAUBEN MUTTER BRECHKOPF	1.50.115
Dado	Nut	Écrou	Mutter	\varnothing 19-27 M12-M18
Peso	Weight	Poids	Gewicht	4,9 kg
Dimensioni mm	Dimensions mm	Dimensions mm	Dimensionen mm	220x112x90

TESTA TAGLIA PIATTO TP120x12 DE
TP120x12 DE FLAT BAR CUTTING HEAD
COD. 1.55.056



da abbinare a MU26 DE cod. 1.50.149
 matches MU26 DE item 1.50.149

TESTA TAGLIO PIATTO	PLATE CUTTING HEAD	TÊTE COUPE PLAT	FLACHEISEN SCHNEID KOPF	1.55.056
Piatto	Flat steel	Plat	Flacheisen	120x12 mm
Peso	Weight	Poids	Gewicht	21 kg
Dimensioni mm	Dimensions mm	Dimensions mm	Dimensionen mm	230x180x120

TESTA F100
F100 HEAD
COD. 1.50.111

TESTA F100 DE (DOPPIO EFFETTO)
F100 DE HEAD (DOUBLE ACTING)
COD. 1.50.121



TESTA F100	F100 HEAD	F100 TÊTE	F100 KOPF	1.50.111	1.50.121
Apertura lame in punta	Blades opening at the tip	Lames ourvert. en tête	Klingen öffnung an der Spitze	80 mm	100 mm
Apertura lame in centro	Blades opening at the centre	Lames ourvert. au centre	Klingen öffnung in der Mitte	95 mm	113 mm
Profondità lame	Blades depth	Profondeur lames	Klingentiefe	100 mm	100 mm
Peso	Weight	Poids	Gewicht	11,4 kg	12,5 kg
Dimensioni mm	Dimensions mm	Dimensions mm	Dimensionen mm	322x180x230	322x185x217

TESTA PUNZONATRICE
PUNCHING HEAD
PZ 28/65 **COD. 1.50.114**
PZ 28/65 DE **COD. 1.50.694**



PUNZONATRICE	PUNCHING MACHINE	POINÇONNEUSE	STANZ MASCHINE	1.50.114 1.50.694
Potenza	Power	Puissance	Potenz	25-32 ton
Foro	Hole	Trou	Bohrung	Ø max 22 mm
Spessore	Thickness	Épaisseur	Wandstärke	10 mm
Peso	Weight	Poids	Gewicht	34 kg
Dimensioni mm	Dimensions mm	Dimensions mm	Dimensionen mm	340x230x130

TESTA PER PIEGATURA A RAGGIO
RADIUS BENDING HEAD
TPR20 **COD. 1.50.745**
TPR26 **COD. 1.50.732**



TESTA PER PIEGA TPR20-TPR26	BENDING HEAD TPR20-TPR26	TÊTE DE COUPE TPR20-TPR26	SCHNEID KOPF TPR20-TPR26	1.50.745	1.50.732
Tondo diam. max	Round steel max	Rond a beton max	Rundeisen für Beton max	Ø 6÷20 mm	Ø 6÷26 mm
Peso	Weight	Poids	Gewicht	10,7 kg	15,2 kg
Dimensioni mm	Dimensions mm	Dimensions mm	Dimensionen mm	210x260x110	220x290x130

**TESTA DIVARICATRICE
SPREADING HEAD
D180 COD. 1.50.112
240 DE COD. 1.50.122**



TESTA DIVARICATORE	SPREADING HEAD	TÊTE ECARTEUR	SPREIZER	1.50.112	1.50.122
Apertura in punta	Opening at the tip	Ouverture en tête	Max öffnung an der Spitze	180 mm	250 mm
Potenza in punta	Power at the point	Puissance en tête	Potenz an der Spitze	8 ton	12 ton
Potenza a metà leva	Power at the lever centre	Puissance au centre levier	Potenz an dem Hebel Zentrum	13 ton	24 ton
Potenza a inizio leve	Power at lever beginning	Puissance au debut levier	Potenz am Hebel Anfang	21 ton	36 ton
Peso	Weight	Poids	Gewicht	9,1 kg	11 kg
Dimensioni mm	Dimensions mm	Dimensions mm	Dimensionen mm	325x195x215	380x185x216

**CILINDRO PORTA TESTE INTERCAMBIABILI DE
DOUBLE ACTING HEAD CARRIER CYLINDER
COD. 1.50.123**

Consente il collegamento delle teste intercambiabili DE a una centralina idraulica.

Allows DE interchangeable heads connection to an hydraulic pump.



CILINDRO PORTA TESTE	HEAD CARRIER CYLINDER	CYLINDRE PORTE-TÊTE	KOPFTRAGER ZYLINDER	1.50.123
Potenza	Power	Puissance	Potenz	40 ton
Pressione	Pressure	Pression	Druck	700 bar
Peso	Weight	Poids	Gewicht	11 kg
Dimensioni mm	Dimensions mm	Dimensions mm	Dimensionen mm	320x120x205

Tabella per il corretto abbinamento corpo macchina → testa intercambiabile
Instructions for the proper tool body → interchangeable head match

CORPO MACCHINA TOOL BODY		TESTA INTERCAMBIABILE INTERCHANGEABLE HEAD											
MU 22N	1.50.1952	T14	T22	P22	TW19	TR40	RD26	TPR20	F100	PZ 28/65	D180	TF32	TS500
TPS 22N	1.50.2057	1.50.116	1.50.117	1.50.1915	1.50.118	1.50.061	1.50.115	1.50.745	1.50.111	1.50.114	1.50.112	1.50.064	1.50.106
MU 26N	1.50.1891	T26	P26	TPR26									
TPS 26N	1.50.2032	1.50.085	1.50.1890	1.50.732									
MU 26 DE	1.50.149	TF32DE	F100 DE	PZ 28/65 DE	DE240	TP120x12							
TPS 26 DE	1.50.150	1.50.679	1.50.121	1.50.694	1.50.122	1.55.056							

**TESTE INTERCAMBIABILI
INTERCHANGEABLE HEADS**

 Una gamma completa di punzonatrici a batteria, elettriche o azionate da centralina idraulica. Tutte le macchine sono a "Doppio Effetto" (DE) per una agevole estrazione del punzone senza inceppamenti.

 A complete range of battery, electrical and pump operated punching machines. All the tools are "Double Acting" (DE) for an effective jam-free punch retraction.

PUNZONATRICE A BATTERIA PG 22/60 DE
PG 22/60 DE CORDLESS PUNCHING MACHINE
COD. 1.50.2395



PUNZONATRICE A BATTERIA PG 22/120N DE
PG 22/120N DE CORDLESS PUNCHING MACHINE
COD. 1.50.2507



Profondità incavo 120 mm
120 mm throat



PUNZONATRICE A BATTERIA PB500 DE
PB500 DE CORDLESS PUNCHING MACHINE
COD. 1.50.2399



Tutte le macchine sono dotate di appoggio regolabile e estrattori
All the tools are equipped with adjustable support and strippers

Punzoni quadrati e ovali disponibili su richiesta
Squared and oval punches available

PUNZONATRICE	PUNCHING MACHINE	POINÇONNEUSE	STANZ-MASCHINEN	1.50.2395	1.50.2507	1.50.2399
Tensione	Voltage	Tension	Spannung	18V/2,0Ah	18V/2,0Ah	18V/2,0Ah
Potenza	Power	Puissance	Potenz	12 ton	12 ton	21 ton
Foro max	Hole max	Trou max	Bohrung max	22 mm	30 mm*	30 mm
Spessore	Thickness	Épaisseur	Wandstärke	5 mm	5 mm	12 mm
Pressione	Pressure	Pression	Druck	550 bar	550 bar	550 bar
Peso con batteria al Litio	Weight including Lithium ion battery	Poids	Gewicht	14,2 kg	14,7 kg	14,7 kg

Tutte le macchine a batteria hanno una batteria al Litio in dotazione. Per batterie supplementari, carica batteria ed altri accessori vedi pag. 42
All cordless tools are supplied with one Lithium ion battery. For spare batteries, charger and other accessories see page 42

**PUNZONATRICE PZN 28 DE
MATRICE SPORGENTE
PZN 28 DE PUNCHING MACHINE
RAISED DIE
COD. 1.50.1972**



**Ideale per profili metallici
a T - C - L
Suitable for T - C - L
metal profiles**

**Optional: base d'appoggio
stand
COD. 1.50.2291**



PUNZONATRICE PZN 28 DE	PUNCHING MACHINE	POINÇONNEUSE	STANZ- MASCHINEN	1.50.1972	1.50.1963
Tensione	Voltage	Tension	Spannung	230V/50Hz	230V/50Hz
Potenza	Power	Puissance	Potenz	28 ton	28 ton
Foro max	Hole max	Trou max	Bohrung max	30 mm	30 mm
Spessore	Thickness	Épaisseur	Wandstärke	10 mm	10 mm
Peso	Weight	Poids	Gewicht	25 kg	25,4 kg
Pressione	Pressure	Pression	Druck	550 bar	550 bar

**PUNZONATRICE PZN 28 DE
PZN 28 DE PUNCHING MACHINE
COD. 1.50.1963**



**Matrice piana
ideale per punzonare
putrelle e travi
Flat die, ideal for
punching joists and
beams**

**TESTA PUNZONATRICE DE PZ 28/65 DE
PZ 28/65 DE PUNCHING HEAD DE
COD. 1.50.694**

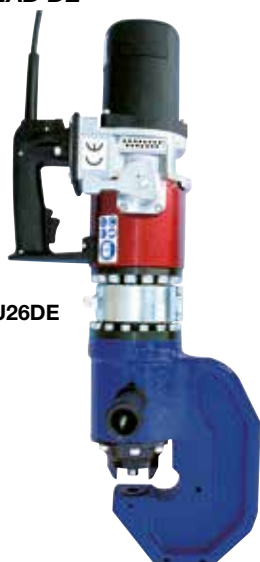

**Da abbinare a corpo cesoia MU26DE
Matches tool body MU26DE
COD. 1.50.149**

PUNZONATRICE PZ 28/65 DE	PUNCHING MACHINE	POINÇONNEUSE	STANZ- MASCHINEN	1.50.694
Tensione	Voltage	Tension	Spannung	230V/50Hz
Potenza	Power	Puissance	Potenz	40 ton/640 bar
Foro max	Hole max	Trou max	Bohrung max	22 mm
Spessore	Thickness	Épaisseur	Wandstärke	10 mm
Peso	Weight	Poids	Gewicht	34 kg
Pressione	Pressure	Pression	Druck	700 bar

PUNZONATRICE A DOPPIO EFFETTO
DOUBLE ACTING PUNCHING MACHINE
P35/110 DE COD. 1.50.653
PZ C35/150 DE COD. 1.55.057

Azionamento con centralina idraulica per impieghi pesanti
 Pump operated for heavy-duty applications



PUNZONATRICE	PUNCHING MACHINE	POINÇONNEUSE	STANZ-MASCHINEN	1.50.653	1.55.057
Tensione	Voltage	Tension	Spannung	230V/50Hz 440V/50Hz	440V/50Hz
Potenza	Power	Puissance	Potenz	44 ton	80 ton
Foro max	Hole max	Trou max	Bohrung max	30 mm	35 mm
Spessore	Thickness	Épaisseur	Wandstärke	10 mm	16 mm
Peso	Weight	Poids	Gewicht	55 kg	145 kg
Pressione	Pressure	Pression	Druck	700 bar	700 bar

DIMENSIONI DELLE TESTE DI PUNZONATURA
PUNCHING HEADS DIMENSIONS

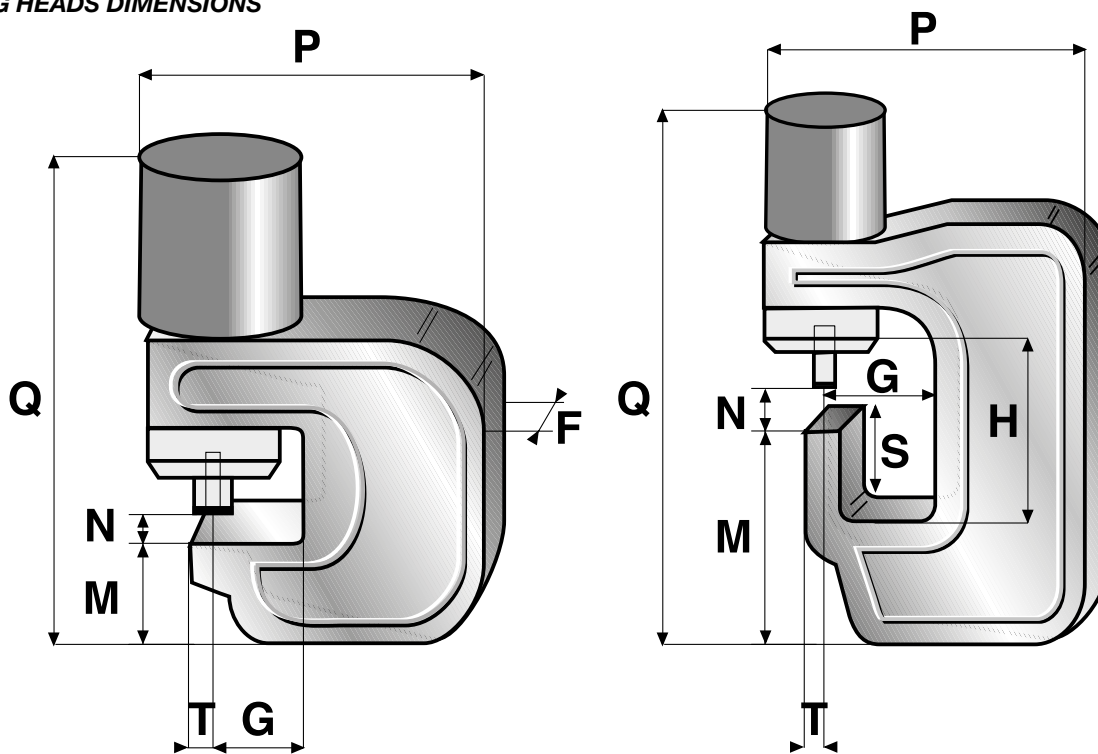

MISURE IN mm - SIZES (mm)	F	G	H	M	N	P	Q	S	T
PG 22/60 DE	40	70	/	109	15	178	217	43	25
PG 22/120 DE	40	120	/	96	15	250	204	/	27,5
PB 500 DE	53	50	/	111	16	172	216	52	22,5
PZ 28/65 head	60	65	/	100	20	200	173	/	28,5
PZN 28 DE cod. 1.50.1963	65	59	/	89	16	180	230	/	29
PZN 28 DE cod. 1.50.1972	65	57	/	143	12	195	280	52	24,5
P 35/110 DE	100	110	/	110	25	342	265	/	34,5
PZ C35/150 DE	120	150	/	173	35	410	415	/	35

CESOIA T8 CE - COMANDO ELETTRICO
T8 CE CUTTER - ELECTRIC CONTROL
COD. 1.50.638

CESOIA T8 CM - COMANDO MECCANICO
T8 CM CUTTER - MECHANICAL CONTROL
COD. 1.50.637



Doppio effetto
Double acting

CESOIA T8 CM-CE	SHEAR T8 CM-CE	CISAILLE T8 CM-CE	SCHERE T8 CM-CE	1.50.637	1.50.638
Pressione	Pressure	Pression	Druck	700 bar	700 bar
Potenza di spinta pistone	Piston push power	Pouvoir de poussée du piston	Druckkraft des Kolbens	8 ton	8 ton
Apertura lame	Blades opening	Ouverture des lames	Öffnung der Schneideklängen	35 mm	35 mm
Taglio Ø	Cut Ø	Coupe Ø	Schneide Ø	15 mm	15 mm
Taglio max □	Cut max □	Coupe max □	Schneide max □	30x4 mm	30x4 mm
Peso	Weight	Poids	Gewicht	3,5 kg	3,5 kg
Dimensioni mm	Dimensions mm	Dimensions mm	Dimensionen mm	70x340x110	70x340x160

CILINDRO T16 COMPLETO DI BINATO mt 3
T16 CYLINDER - HOSES LENGHT 3 m
COD. 1.50.608

CILINDRO T16 CON COMANDO MECCANICO
T16 CYLINDER MECHANICAL CONTROL
COD. 1.55.033



Doppio effetto
Double acting

CILINDRO T16	CYLINDER T16	CYLINDRE T16	ZYLINDER T16	1.50.608	1.55.033
Pressione	Pressure	Pression	Druck	700 bar	700 bar
Potenza di spinta pistone	Piston push power	Pouvoir de poussée du piston	Druckkraft des Kolbens	16 ton	16 ton
Taglio max Ø	Cut max Ø	Coupe max Ø	Schneide max Ø	16 mm	16 mm
Dimensioni mm	Dimensions mm	Dimensions mm	Dimensionen mm	265x220x90	410x50x130
Peso	Weight	Poids	Gewicht	5 kg	7,5 kg

CILINDRO T18
T18 CYLINDER
COD. 1.50.1148



Doppio effetto
Double acting

CILINDRO T18	CYLINDER T18	CYLINDRE T18	ZYLINDER T18	1.50.1148
Pressione	Pressure	Pression	Druck	700 bar
Potenza	Power	Puissance	Potenz	16 ton
Taglio max Ø	Cut max Ø	Coupe max Ø	Schneide max Ø	18 mm
Peso	Weight	Poids	Gewicht	5 kg
Dimensioni mm	Dimensions mm	Dimensions mm	Dimensionen mm	265x220x90

**CILINDRO TAGLIA TONDINO
REBAR CUTTING CYLINDER**
T50 COD. 1.50.167
T35/63 COD. 1.50.1971
T30 COD. 1.55.076
T22 COD. 1.55.070

CILINDRO	CYLINDER	1.50.167 T50	1.50.1971 T35/63	1.55.076 T30	1.55.070 T22
Pressione	Pressure	700 bar	700 bar	700 bar	700 bar
Potenza	Power	108 ton	63 ton	40 ton	30 ton
Taglio max Ø	Cut max Ø	52 mm	35 mm	30 mm	22 mm
Peso	Weight	120 kg	50 kg	14 kg	10,8 kg
Dimensioni mm	Dimensions mm	740x244x260	600x200x260	380x150x220	350x140x200



Versione con comando meccanico
Mechanical control version

**Doppio effetto
Double acting**

**Impieghi gravosi
Heavy duty applications**



Altri cilindri di taglio disponibili su richiesta
Other cutting cylinders available upon request



Esecuzione di un taglio sott'acqua
Underwater rod cutting

**ATTREZZATURA PER TAGLIO DI MATEROZZE E FUSIONI IN ALLUMINIO - DISPONIBILI A RICHIESTA
ALUMINUM CASTING CUTTING TOOLS AVAILABLE UPON REQUEST**





Una gamma completa di attrezzi a Doppio Effetto per il taglio di cavi e funi.

- Doppio Effetto contro ogni rischio di inceppamento
- maggiore sicurezza rispetto al taglio a disco
- compatti - leggeri - veloci - affidabili
- utilizzabili in ogni posizione
- lame temperate ri-affilabili



A complete range of Double-Acting cable and rope cutters.

- Double Acting (100% jam free system)
- safer than grinding
- compact, lightweight, fast, reliable
- work in any position
- blades can be re-sharpened

**CILINDRO TAGLIA FUNI TF 63 DE
TF 63 DE WIRE ROPE CUTTER
COD. 1.50.2611**



TAGLIA CAVI	CABLE CUTTER	COUPE CABLE	KABEL SCHNEIDER	1.50.2611
Potenza idraulica	Hydraulic power	Puissance hydraulique	Hydraulische Potenz	87 ton/700 bar
Taglio max Ø	Cut max Ø	Coupe max Ø	Schneide max Ø	63 mm
Peso	Weight	Poids	Gewicht	67 kg
Dimensioni mm	Dimensions mm	Dimensions mm	Dimensionen mm	670x240x176

**CILINDRO PER TAGLIO CAVO
CABLE CUTTER
TC 90 COD. 1.55.023
TC 140 COD. 1.50.1102**



TAGLIA CAVI	CABLE CUTTER	COUPE CABLE	KABEL SCHNEIDER	1.55.023	1.50.1102
Potenza	Power	Puissance	Potenz	55 ton/700 bar	55 ton/700 bar
Taglio max Ø	Cut max Ø	Coupe max Ø	Schneide max Ø	90 mm	140 mm
Peso	Weight	Poids	Gewicht	80 kg	90 kg
Dimensioni mm	Dimensions mm	Dimensions mm	Dimensionen mm	675x230x200	925x300x210

**CILINDRO TAGLIA CAVI TC180
TC180 CABLE CUTTER
COD. 1.50.2086**



TAGLIA CAVI	CABLE CUTTER	COUPE CABLE	KABEL SCHNEIDER	1.50.2086
Potenza idraulica	Hydraulic power	Puissance hydraulique	Hydraulische Potenz	79 ton/700 bar
Taglio max Ø	Cut max Ø	Coupe max Ø	Schneide max Ø	180 mm
Peso	Weight	Poids	Gewicht	160 kg
Dimensioni mm	Dimensions mm	Dimensions mm	Dimensionen mm	1370x550x400

Prodotti correlati: vedi pag. 7-8 mod. TF32 DE - TC 55F42 DE
Related products: see pages 7-8 mod. TF32 DE - TC 55F42 DE

 Cesoie idrauliche portatili a Doppio Effetto per taglio/demolizione industriali

- Doppio Effetto contro ogni rischio di inceppamento
- Maggiore sicurezza rispetto al taglio a disco - lame temperate ri-affilabili
- Compatte, leggere, veloci, affidabili - utilizzabili in ogni posizione
- > Vasta gamma di applicazioni mobili o fisse: taglio cavi e funi - recupero autoveicoli - fonderie - demolizione - taglio tubi e profili metallici
- > Centralina idraulica consigliata: CB700 motore trifase - cod.150798
- > Progettate e realizzate interamente in Italia

 Portable Double-Acting cutters for industrial/demolition applications.

- Double Acting (100% blockage free system)
- Safer than grinding - blades can be re-sharpened
- Compact, lightweight, fast, reliable - can be used in any position
- > Many mobile or stationary applications: cable, steel pipes and wire ropes cutting - foundries - car recycling - demolitions
- > Recommended pump: CB700 three-phase electric motor code 150798
- > Italian design and manufacturing

Tutti i modelli sono disponibili con comando elettrico per l'azionamento tramite centralina idraulica dotata di elettrovalvole
Electric control model available; requiring a pump fitted with solenoid valves

ATTREZZO MULTIUSO MDC360
MDC360 COMBI TOOL
T40 COD. 1.50.2479



Forza di schiacciamento (25 mm dalla punta)	Squeezing force (25 mm from the tip)	7,3 t (71,6 KN)
Forza divaricatore (25 mm dalla punta)	Spreading force (25 mm from the tip)	5,8 t

ATTREZZO MULTIUSO	COMBI TOOL	OUTIL MULTIPLE	VIELFÄLTIGES WERKZEUG	1.50.2479
Potenza idraulica	Hydraulic power	Puissance hydraulique	Hydraulische Potenz	40 ton/700 bar
Apertura max	Max. opening	Ouverture max.	Max. Öffnung	360 mm
Peso	Weight	Poids	Gewicht	17 kg
Dimensioni mm	Dimensions mm	Dimensions mm	Dimensionen mm	706x360x184

CESOIA A FORBICE F170N
F170N CUTTER
COD. 1.50.2033



CESOIA	CUTTER	CISAILLE	SCHNEIDER	1.50.2033
Potenza di taglio max nell'incavo	Cutting power at the notch	Pouvoir de coupe à la breche	Schneidepotenz an der kerbe	78 ton/700 bar
Apertura lame	Blades opening	Ouverture des lames	Öffnung der Schneideklängen	Ø 170 max
Peso	Weight	Poids	Gewicht	24,2 kg
Dimensioni mm	Dimensions mm	Dimensions mm	Dimensionen mm	810x280x180

CESOIA A FORBICE CUTTER
F130N COD. 1.50.2055
F145N COD. 1.50.2049

CESOIA F145N CON COMANDO ELETTRICO CUTTER F145N ELECTRIC CONTROL
COD. 1.50.2569



CESOIA	CUTTER	CISAILLE	SCHNEIDER	1.50.2055 F130N	1.50.2049 F145N
Potenza di taglio max nell'incavo	Cutting power at the notch	Pouvoir de coupe à la breche	Schneidepotenz an der kerbe	24,5 ton / 700 bar	30 ton / 700 bar
Apertura lame	Blades opening	Ouverture des lames	Öffnung der Schneideklängen	Ø 130 max	Ø 145 max
Peso	Weight	Poids	Gewicht	11,8 kg	18 kg
Dimensioni mm	Dimensions mm	Dimensions mm	Dimensionen mm	670x235x150	780x255x160

**DIVARICATORE
SPREADER**

DE 670/27 COD. 1.50.628

DE 670/40 COD. 1.50.677

DE 850/36 COD. 1.50.202

DE 850/50 COD. 1.50.676



DIVARICATORE	SPREADER	ECARTEUR	VERBREITER	1.50.628	1.50.677	1.50.202	1.50.676
Pressione	Pressure	Pression	Druck	700 bar	700 bar	700 bar	700 bar
Apertura max	Max. opening	Ouverture max.	Max. Öffnung	670 mm	670 mm	850 mm	850 mm
Potenza in punta divaricatore	Opener power at the head	Pouvoir en tête de l'écarteur	Potenz an der Spitze des Verbreiters	3 ton	4,7	3,8	5,5
Potenza a metà divaricatore	Opener power at the centre	Pouvoir au centre de l'écarteur	Potenz an der Mitte des Verbreiters	5 ton	6,5	5,5	7,5
Potenza max schiacciamento in punta	Max Crushing power at the head	Pouvoir en tête	Max Preßkraft an Spitze	2,4 ton	3,5	3,3	4,4
Peso	Weight	Poids	Gewicht	kg 18	kg 20	kg 24	kg 27
Dimensioni mm	Dimensions mm	Dimensions mm	Dimensionen mm	655x300x180	655x300x180	950x300x180	950x300x180

**CILINDRO CON CESOIA F160 DE CON LAME GUIDATE
F160 DE CUTTER - GUIDED BLADES
COD. 1.50.1015**



CESOIA	CUTTER	CISAILLE	SCHNEIDER	1.50.1015
Pressione	Pressure	Pression	Druck	700 bar
Potenza max al centro	Cutting power at the centre	Pouvoir de coupe au centre	Schneidepotenz an dem Zentrum	14 ton
Apertura lame	Blades opening	Ouverture des lames	Öffnung der Schneideklingen	160 mm
Peso	Weight	Poids	Gewicht	23 kg
Dimensioni mm	Dimensions mm	Dimensions mm	Dimensionen mm	860x120x320

RODITRICI - NIBBLERS

**RODITRICE
NIBBLER**

RP5 COD. 1.50.751

RP10 COD. 1.50.754



RODITRICE	NIBBLER	GRIGNOTEUSE	KNABBER	1.50.751 RP5	1.50.754 RP10
Potenza idraulica	Hydraulic power	Puissance hydraulique	Hydraulische Potenz	11 ton	19,5 ton
Spessore	Thickness	Épaisseur	Wandstärke	5 mm R=40/kg/mm ²	10 mm R=40/kg/mm ²
Peso	Weight	Poids	Gewicht	10 kg	18,5 kg
Dimensioni mm	Dimensions mm	Dimensions mm	Dimensionen mm	120x100x610	350x360x210

CILINDRO CON TESTA RADDRIZZATRICE R16
STRAIGHTENING CYLINDER R16
COD. 1.50.607



VERSIONE PESANTE
HEAVY DUTY VERSION
COD. 1.55.048

RADDRIZZATORE	STRAIGHTENER	REDRESSEUSE	RICHTER	1.50.607	1.50.048
Potenza	Power	Puissance	Potenz	6 ton	6 ton
Pressione	Pressure	Pression	Druck	550 bar	400 bar
Peso	Weight	Poids	Gewicht	6 kg	11 kg
Dimensioni mm	Dimensions mm	Dimensions mm	Dimensionen mm	450x200x230	450x200x230

 Una gamma completa di attrezzi per la raddrizzatura del tondino. Tutti i modelli hanno la corsa del pistone regolabile in funzione dei diversi diametri della barra.

 A complete range of rebar straightening tools. All the models are provided with adjustable piston stroke to fit different rebar sizes

MACCHINA RADDRIZZATRICE
STRAIGHTENING TOOL
RD 8-20 COD. 1.50.2022
RD 20-32 COD. 1.50.2036



RADDRIZZATORE	STRAIGHTENER	REDRESSEUSE	RICHTER	1.50.2022 RD 8-20	1.50.2036 RD 20-32
Potenza idraulica	Hydraulic power	Puissance hydraulique	Hydraulische Potenz	5 ton/380 bar	11 ton/380 bar
Ø min-max	Ø min-max	Ø min-max	Ø min-max	8 ÷ 20 mm	20 ÷ 32 mm
Peso	Weight	Poids	Gewicht	9,4 kg	15,8 kg

MACCHINA RADDRIZZATRICE A BATTERIA RD 8-20
RD 8-20 CORDLESS STRAIGHTENING TOOL
COD. 1.50.2401



Tutte le macchine a batteria hanno una batteria al Litio in dotazione. Per batterie supplementari, carica batteria ed altri accessori vedi pag. 42

All cordless tools are supplied with one Lithium ion battery. For spare batteries, charger and other accessories see page 42

RADDRIZZATORE	STRAIGHTENER	REDRESSEUSE	RICHTER	1.50.2401
Potenza idraulica	Hydraulic power	Puissance hydraulique	Hydraulische Potenz	4 ton/200 bar
Ø min-max	Ø min-max	Ø min-max	Ø min-max	8 ÷ 20 mm
Peso con batteria al Litio	Weight including Lithium ion battery	Poids	Gewicht	8,0 kg

CENTRALINA IDRAULICA CB700 L4 E - TRIFASE**CB700 L4 E - TRIPHASE PUMP****COD. 1.50.798**

CENTRALINA	PUMP	CENTRALE	AGGREGAT	1.50.794	1.50.798	1.50.855
Motore	Motor	Moteur	Motor	HP 5,5	HP 5,5-4 kW	HP 12,5
Tensione	Voltage	Tension	Spannung	Petrol engine	400V/50Hz triphase	400V/50Hz triphase
Giri	RPM	Tours	Touren	3.000/min	1.420/min	1.450/min
Pressione	Pressure	Pression	Druck	700 bar	700 bar	700 bar
Portata olio	Oil flow	Flux huile	Ölfluß	0=100 bar 6 l/min 100=700 bar 1,6 l/min	4 l/min	0=250 bar 12,3 l/min 250=700 bar 7,0 l/min
Capacità serbatoio	Oil Tank capacity	Capacité réservoir huilé	Öltank-volumen	l 23	l 23	l 90
Peso	Weight	Poids	Gewicht	kg 75	kg 92	kg 232
Dimensioni mm	Dimensions mm	Dimensions mm	Dimensionen mm	680x490x710	680x490x710	700x470x890

**CENTRALINA IDRAULICA
CB700 L4 S MOTORE A SCOPPIO
CB700 L4 S - PETROL ENGINE PUMP
COD. 1.50.794**
**Altre versioni disponibili - Other versions available**

- 1.50.846** CB700 L4 230V con scambiatore
CB700 L4 230V cooled
- 1.50.824** CB700 L4 trifase con scambiatore a doppi attacchi
CB700 L4 triphase - cooled - double connections
- 1.50.804** CB700 L4 trifase con 2 elettrovalvole a 700 bar
CB700 L4 triphase with 2 solenoid valves 700 bar
- 1.50.835** CB700 L4 trifase con scambiatore e 2 elettrovalvole a 700 bar
CB700 L4 triphase with 2 solenoid valves 700 bar - cooled
- 1.50.814** CB700 L4 trifase a doppi attacchi e 2 elettrovalvole a 700 bar
CB700 L4 triphase with double connections and 2 solenoid valves 700 bar
- 1.50.878** CB700 L4 trifase a doppi attacchi con 4 elettrovalvole a 700 bar
CB700 L4 triphase with double connections and 4 solenoid valves 700 bar
- 1.50.2065** CB700 L4 trifase a doppi attacchi con 4 elettrovalvole a 700 bar con scambiatore
CB700 L4 triphase with double connections and 4 solenoid valves 700 bar - cooled
- 1.50.855** CB700 L7 trifase con 2 elettrovalvole a 700 bar - con scambiatore
CB700 L7 triphase with 2 solenoid valves 700 bar - cooled

CENTRALINA IDRAULICA VDS700 G28 MOTORE ELETTRICO**VDS700 G28 PUMP - 230V ELECTRIC MOTOR****COD. 1.50.176**

CENTRALINA	PUMP	CENTRALE	AGGREGAT	1.50.176
Tensione	Voltage	Tension	Spannung	230V/50Hz
Giri	RPM	Tours	Touren	2.800/min
Pressione	Pressure	Pression	Druck	700 bar
Portata olio	Oil flow	Flux huile	Ölfluß	0=700 bar 1,2 l/min
Capacità serbatoio	Oil Tank capacity	Capacité réservoir huilé	Öltank-volumen	l 2,7
Peso	Weight	Poids	Gewicht	kg 23
Dimensioni mm	Dimensions mm	Dimensions mm	Dimensionen mm	400x230x440

CENTRALINA IDRAULICA VDS700 G28 MOTORE ELETTRICO CON SCAMBIATORE
VDS700 G28 PUMP - 230V ELECTRIC MOTOR - COOLED
COD. 1.50.2082

Altre versioni disponibili - Other versions available

- 1.50.604** VDS700 G28 - 230V con 2 elettrovalvole a 700 bar
VDS700 G28 - 230V with 2 solenoid valves 700 bar
- 1.50.839** VDS700 G28 - 230V con 2 elettrovalvole a 700 bar con scambiatore
VDS700 G28 - 230V with 2 solenoid valves 700 bar - cooled
- 1.50.241** VDS700 G28 - 230V con 2 elettrovalvole a 700 bar a doppi attacchi
VDS700 G28 - 230V with 2 solenoid valves 700 bar - double connections

CENTRALINA IDRAULICA VDS700 MOTORE ELETTRICO
VDS700 PUMP - 230V ELECTRIC MOTOR
COD. 1.50.173

CENTRALINA	PUMP	CENTRALE	AGGREGAT	1.50.173	1.50.188	1.50.189
Tensione	Voltage	Tension	Spannung	230V/50Hz	Petrol engine	230V/50Hz
Giri	RPM	Tours	Touren	14.000/min	9.000/min	13.000/min
Pressione	Pressure	Pression	Druck	380 bar	700 bar	700 bar
Portata olio	Oil flow	Flux huile	Ölfluß	0÷100 bar 6 l/min 100÷380 bar 3 l/min	0÷100 bar 2,5 l/min 100÷700 bar 1,25 l/min	0÷100 bar 3 l/min
Capacità serbatoio	Oil Tank capacity	Capacité réservoir huilé	Öltank-volumen	12,7	12,7	12,7
Peso	Weight	Poids	Gewicht	kg 18	kg 16	kg 17
Dimensioni mm	Dimensions mm	Dimensions mm	Dimensionen mm	340x240x360	360x280x420	350x230x360

CENTRALINA IDRAULICA VDS 700 MOTORE A SCOPPIO
VDS700 PUMP - PETROL ENGINE VERSION
COD. 1.50.188
Altre versioni disponibili - Other versions available

- 1.50.189** VDS700 L3 - 230V con 2 elettrovalvole a 700 bar (portata olio 3 l/min)
VDS700 L3 - 230V with 2 solenoid valves 700 bar (oil flow 3 l/min)
- 1.50.1836** VDS700 motore a scoppio a doppi attacchi
VDS700 petrol engine - double connections



CENTRALINA IDRAULICA MP700 E - 230V CON SCAMBIATORE

MP700 E PUMP - 230V - COOLED

COD. 1.50.2347



CENTRALINA	PUMP	CENTRALE	AGGREGAT	1.50.2345	1.50.2347	1.50.2709
Motore	Motor	Moteur	Motor	HP 4,4	HP 3	HP 3
Tensione	Voltage	Tension	Spannung	Petrol engine	230V/50Hz	400V/50Hz triphase
Giri	RPM	Tours	Touren	3.000/min	1.400/min	1.400/min
Pressione	Pressure	Pression	Druck	700 bar	700 bar	700 bar
Portata olio	Oil flow	Flux huile	Öfluß	0=200 bar 4 l/min 200=700 bar 1,6 l/min	0=200 bar 3,8 l/min 200=700 bar 1,5 l/min	0=200 bar 4,9 l/min 200=700 bar 1,9 l/min
Capacità serbatoio	Oil Tank capacity	Capacité réservoir huilé	Öltankvolumen	l 4	l 4	l 4
Peso	Weight	Poids	Gewicht	kg 36	kg 46,5	kg 46,5
Dimensioni mm	Dimensions mm	Dimensions mm	Dimensionen mm	460x500x360	540x500x360	540x500x360

CENTRALINA IDRAULICA MP700 S - A DOPPI ATTACCHI - MOTORE A SCOPPIO

MP700 S PUMP - DOUBLE CONNECTIONS - PETROL ENGINE

COD. 1.50.2345



Altre versioni disponibili - Other versions available

1.50.2353 MP700 E 230V con 2 elettrovalvole a 700 bar
MP700 E 230V with 2 solenoid valves 700 bar

1.50.2355 MP700 E 230V con 2 elettrovalvole a 700 bar con scambiatore
MP700 E 230V with 2 solenoid valves 700 bar - cooled

1.50.2709 MP700 E 400V con scambiatore
MP700 E 400V with cooler

1.50.2356 MP700 E 400V con 2 elettrovalvole a 700 bar
MP700 E 400V with 2 solenoid valves 700 bar

1.50.2357 MP700 E 400V con 2 elettrovalvole a 700 bar con scambiatore
MP700 E 400V with 2 solenoid valves 700 bar - cooled

1.50.2358 MP700 E 400V con 4 elettrovalvole a 700 bar con scambiatore - doppi attacchi
MP700 E 400V with 4 solenoid valves 700 bar - cooled - double connections

1.50.2349 MP700 S motore a scoppio - con scambiatore - doppi attacchi
MP700 S petrol engine - cooled - double connections

Criteri di scelta delle centraline idrauliche:

Utilizzo per lunghi periodi: centraline del tipo CB700; abbinare i modelli con elettrovalvole ai cilindri con comando elettrico.
Utilizzo per brevi periodi: centraline del tipo VDS700; abbinare i modelli con elettrovalvole ai cilindri con comando elettrico.

Selection criteria for hydraulic pumps:

Continuous use: CB700 pumps; select models with solenoid valves for tools equipped with electric control.

Short operation cycles: VDS700 pumps; select models with solenoid valves for tools equipped with electric control.

POMPA MANUALE

HAND PUMP

**MOLTE VERSIONI DISPONIBILI
MORE MODELS AVAILABLE**



POMPA MANUALE	HAND PUMP	POMPE À MAIN	HANDPUMPE	//
Pressione I/II stadio	Pressure I/II phase	Pression I/II phase	Druck I/II phase	bar 35/700
Portata olio I/II stadio	Oil flow I/II phase	Flux d'huile I/II phase	Öfluß I/II phase	in funzione della versione depending on version
Doppio effetto	Double acting	Double effect	Doppelt effekt	SI/YES
Capacità serbatoio	Oil Tank capacity	Capacité réservoir huilé	Öltankvolumen	in funzione della versione depending on version
Peso	Weight	Poids	Gewicht	in funzione della versione depending on version
Dimensioni mm	Dimensions mm	Dimensions mm	Dimensionen mm	in funzione della versione depending on version

 Le pinze idrauliche prodotte dalla “Edilgrappa S.r.l.” rappresentano oggi le nuove frontiere per la demolizione controllata.

Tutti i modelli prodotti accomunano potenza e leggerezza grazie all'unione di leveraggi e ganasce in nobili leghe leggere con puntali di pregiato e durissimo acciaio da utensili; il campo di applicazione varia dal laterizio al cemento armato ed il loro impiego diviene necessario dove la demolizione vada eseguita in assenza di rumore, polvere, vibrazioni e/o percussioni o qualora la mole di lavoro richieda uno strumento veloce ed efficace, anche in termini di produttività.

Non inquinano e non richiedono acqua durante il funzionamento.

- la pinza 315DE permette di demolire il calcestruzzo e il cemento armato con potenza e precisione;
- ottima resa ed efficacia su manufatti e fabbricati, scale, pilastri, vasche, fondazioni, travi, ciminiera...
- assenza totale di rumore, polvere, vibrazioni e/o percussioni;
- utilissima per lo sgretolamento del materiale di risulta derivante dal taglio dei muri con troncatrici a disco e/o catena;
- pratica, maneggevole, affidabile;
- azionabile con centralina idraulica a 700 bar.



- crusher 315DE allows the demolition of concrete and reinforced concrete with strength and precision;
- excellent yield and effective on constructions, stairs, pillars, basins, foundations, beams, chimneys, strongrooms...
- noise, dust, vibrations and/or percussions free;
- very useful to crush remains of walls cutted with disc cropper and/or chain;
- practical, handy, reliable;
- can be operated by a 700 bar pump.



**BILANCIATORE PER 315 DE
315 DE BALANCER
COD. 1.10.4304**



**PINZA DEMOLITRICE PER CALCESTRUZZO 315 DE
315 DE CONCRETE CRUSHER
COD. 1.50.691**

PINZA PER CALCESTRUZZO	CONCRETE CRUSHER	PINCE BÉTON	BETONZANGE	1.50.691
Potenza idraulica	Hydraulic power	Puissance hydraulique	Hydraulische Potenz	30 ton
Pressione di esercizio	Working pressure	Pression de travail	Arbeitsdruck	700 bar
Spessore max. sgretolabile	Max. crush thickness	Épaisseur max. effritable	Max. abbröckelbare Dicke	30 cm (R=325 kg/cm ²)
Potenza in punta	Power at the head	Pouvoir en tête	Potenz an der spitze	13,6 ton
Peso	Weight	Poids	Gewicht	kg 52
Dimensioni mm	Dimensions mm	Dimensions mm	Dimensionen mm	740X860X180

Il bilanciatore o “azzeratore di pesi” rende facile e maneggevole l'impiego dell'attrezzatura durante l'uso.

The balancer neutralizes the tool's weight making demolition operation easy and manageable.



- la pinza 230 DE T10 frantuma con incredibile potenza e precisione i muri in laterizio e in CLS fino a 20 cm di spessore
- altissima velocità di esecuzione
- leggera, maneggevole, pratica, affidabile
- elimina rumore, polvere, vibrazioni e/o percussioni
- insostituibile negli interventi di ristrutturazione, centri storici, abitati, ospedali, ecc.



- *crusher 230 DE T10 allows the demolition of concrete walls till 20 cm thickness*
- *very high working speed*
- *lightweight, handy, practical, reliable*
- *eliminates noise, dust, vibrations and/or percussions*
- *indispensable in case of renovation, old town centres, urban areas, hospitals etc.*

PINZA PER CALCESTRUZZO 230 DE T10
230 DE T10 CONCRETE CRUSHER
COD. 1.50.2237

Puntale per calcestruzzo

Tip for concrete



PINZA PER CALCESTRUZZO	CONCRETE CRUSHER	PINCE BÉTON	BETONZANGE	1.50.2237
Potenza idraulica	Hydraulic power	Puissance hydraulique	Hydraulische Potenz	20 ton
Pressione di esercizio	Working pressure	Pression de travail	Arbeitsdruck	700 bar
Apertura max	Max. opening	Ouverture max.	Max. Öffnung	23 cm
Potenza in punta	Power at the head	Pouvoir en tête	Potenz an der spitze	10 ton
Spessore max sgretolabile	Max crush thickness	Épaisseur max effritable	Max abbröckelbare dicke	20 cm (R=325 kg/cm ²)
Peso	Weight	Poids	Gewicht	kg 23
Dimensioni mm	Dimensions mm	Dimensions mm	Dimensionen mm	801x510x212



Dotata di protezione morbida trasparente

Fitted with transparent soft protection shield



- la pinza 330 DE T6 frantuma con incredibile potenza e precisione i muri in laterizio;
- altissima velocità di esecuzione;
- leggera, maneggevole, pratica, affidabile;
- elimina rumore, polvere, vibrazioni e/o percussioni;
- insostituibile negli interventi di ristrutturazione, centri storici, abitati, ospedali ecc.

- *crusher 330 DE T6 crumbles with unbelievable strength and precision the brick walls;*
- *very high working velocity;*
- *light, handy, practical, reliable;*
- *noise, dust, vibrations and/or percussions free;*
- *indispensable in case of renovation, old town centres, built-up areas, hospitals etc.*

**PINZA DEMOLITRICE PER LATERIZIO 330 DE T6
330 DE T6 HOLLOW BRICK CRUSHER
COD. 1.50.2301**

Puntale per laterizio

Tip for hollow bricks



I macchinari possono agire sorretti dall'operatore, nel caso dei modelli più leggeri destinati al laterizio, o collegati a un meccanismo di sollevamento qualora si utilizzi la più pesante pinza per il calcestruzzo, capace di sgretolare un muro dello spessore di 40 cm.

PINZA PER LATERIZIO	BRICK CRUSHER	PINCE BRIQUE	ZIEGELABBRUCHZANGE	1.50.2301
Spessore max sgretolabile	Max crush thickness	Épaisseur max effritable	Max abbröckelnbare dicke	30 cm (R=180 kg/cm ²)
Potenza in punta	Power at the head	Pouvoir en tête	Potenz an der spitze	6,5 ton
Peso	Weight	Poids	Gewicht	kg 18,1
Dimensioni mm	Dimensions mm	Dimensions mm	Dimensionen mm	706x480x210

**PINZA 430 DE
430 DE CRUSHER
COD. 1.50.974**



- la pinza 430 DE permette di demolire il calcestruzzo e il cemento armato con potenza e precisione;
- ottima resa ed efficacia su manufatti e fabbricati, scale, pilastri, vasche, fondazioni, travi, ciminere...
- assenza totale di rumore, polvere, vibrazioni e/o percussioni;
- utilissima per lo sgretolamento del materiale di risulta derivante dal taglio dei muri con troncatrici a disco e/o catena;
- pratica, maneggevole, affidabile;
- azionabile con centralina idraulica a 700 bar.



- 430 DE crusher allows the demolition of concrete and reinforced concrete with strength and precision;
- excellent yield and effective on constructions, stairs, pillars, basins, foundations, beams, chimneys, strongrooms...
- noise, dust, vibrations and/or percussions free;
- very useful to crush remains of walls cutted with disc cropper and/or chain;
- practical, handy, reliable;
- can be operated by a 700 bar hydraulic pump



Comando a distanza posto a 3 metri dall'utensile.

Remote control (3 metres from the tool)

Viene fornita con una coppia di puntali di allungamento per la demolizione di pareti fino a 25 cm circa.

It is supplied with a pair of extension tips for the demolition of up to ca. 25 cm thick walls



Da collegare a centraline idrauliche mod. CB700 nella versione trifase o con motore a scoppio.

Requires CB700 hydraulic pump, three-phase motor or petrol engine version.

PINZA 430 DE	CRUSHER 430 DE	PINCE 430 DE	ZANGE 430 DE	1.50.974
Potenza idraulica	Hydraulic power	Puissance hydraulique	Hydraulische Potenz	55 ton/700 bar
Apertura max	Max. opening	Ouverture max.	Max. Öffnung	430 mm
Spessore	Thickness	Épaisseur	Wandstärke	40 cm
Spessore max c/ puntali	Thickness max with extensions	Épaisseur max avec rallonges	Wandstaerke max mit Verlaengerungen	30 cm
Peso	Weight	Poids	Gewicht	kg 90
Dimensioni mm	Dimensions mm	Dimensions mm	Dimensionen mm	800x540x140

PINZA 230 T25 DE
230 T25 DE CRUSHER
COD. 1.50.1178



Da collegare a centraline idrauliche mod. CB700 nella versione trifase o con motore a scoppio.

To be connected to CB700 hydraulic power pack, three-phase motor or petrol engine version.



- la pinza 230 T25 DE permette di demolire il calcestruzzo e il cemento armato con potenza e precisione;
- ottima resa ed efficacia su manufatti e fabbricati, scale, pilastri, vasche, fondazioni, travi, ciminiera...
- assenza totale di rumore, polvere, vibrazioni e/o percussioni;
- utilissima per lo sgretolamento del materiale di risulta derivante dal taglio dei muri con troncatrici a disco e/o catena;
- pratica, maneggevole, affidabile;
- azionabile con centralina idraulica a 700 bar.

Permette la demolizione di pareti in CLS e laterizio a partire da un lato esterno accessibile oppure da una foratura 250x250 mm.



- 230 T25 DE crusher allows the demolition of concrete and reinforced concrete with strength and precision;
- excellent yield and effective on constructions, stairs, pillars, basins, foundations, beams, chimneys, strongrooms...
- without noise, dust, vibrations and/or percussions;
- very useful to crush remains of walls cutted with disc cropper and/or chain;
- practical, handy, reliable;
- can be operated by a 700 bar hydraulic pump.

It makes possible the demolition of concrete or brick walls starting from an accessible outward side or a 250x250 mm hole.

PINZA 230 T25 DE	CRUSHER 230 T25 DE	PINCE 230 T25 DE	ZANGE 230 T25 DE	1.50.1178
Potenza idraulica	Hydraulic power	Puissance hydraulique	Hydraulische Potenz	25 ton/700 bar
Apertura max	Max. opening	Ouverture max.	Max. Öffnung	23 cm
Spessore	Thickness	Épaisseur	Wandstärke	20 cm
Peso	Weight	Poids	Gewicht	kg 34
Dimensioni mm	Dimensions mm	Dimensions mm	Dimensionen mm	900x550x120

ATTREZZO MULTIUSO MDC370
MDC370 COMBITOOL
COD. 1.50.191



- è l'utensile di supporto alle pinze per calcestruzzo;
- veloce, pratico e leggero;
- permette di separare e asportare i blocchi derivanti dalla demolizione del cemento armato, tagliando il tondino Ø 16 che li trattiene alla struttura.



- it is the support tool to the concrete crusher;
- fast, practical and lightweight;
- allows to separate and remove the blocks coming from the concrete demolition by cutting the embedded Ø 16 steel rebars.

La motorizzazione è composta da una centralina idraulica elettrica, mono o tri-fase, o a scoppio, in grado di erogare la portata necessaria di fluido alla pressione operativa di 700 bar; si spiega così la grande potenza di questi nuovi strumenti di lavoro, pur in presenza di una notevole leggerezza. Il collegamento avviene attraverso tubi idraulici ad altissima resistenza.

ATTREZZO MULTIUSO	COMBI TOOL	OUTIL MULTIPLE	VIelfÄLTIGES WERKZEUG	1.50.191
Potenza idraulica	Hydraulic power	Puissance hydraulique	Hydraulische Potenz	20 ton
Pressione di esercizio	Working pressure	Pression de travail	Arbeitsdruck	700 bar
Apertura max	Max. opening	Ouverture max.	Max. Öffnung	360 mm
Peso	Weight	Poids	Gewicht	kg 16,5
Dimensioni mm	Dimensions mm	Dimensions mm	Dimensionen mm	600x500x180

 Una nuova gamma di compatte e leggere pinze idrauliche per la demolizione di pareti in calcestruzzo, da applicare a piccoli escavatori (1.300-5.000 kg). Grazie a ingombri e pesi limitati permettono di accedere all'interno di edifici, zone difficili da raggiungere o spazi angusti. Ora puoi montare sull'escavatore una pinza idraulica professionale e demolire in sicurezza senza produrre rumore, percussioni o vibrazioni!

 A new range of compact and lightweight concrete crushers for small excavators (1.300-5.000 kg). Compact dimensions allow easy access inside buildings, difficult to reach working areas and narrow spaces. It's now possible to fit your excavator with a professional crusher and safely operate without noise, percussions or vibrations!



PINZA 430-2DE T44
CRUSHER 430-2DE T44
COD. 1.50.2120

PINZA 330-DE T34
CRUSHER 330-DE T34
COD. 1.50.2179

Dimensioni	Dimensions	1.50.2120	1.50.2179
Altezza (senza sella)	Height (without bracket)	862 mm	750 mm
Larghezza totale	Length	883 mm	723 mm
Profondità	Width	323 mm	322 mm
Apertura massima puntali	Max jaws opening	435 mm	324 mm
Apertura minima puntali	Min jaws opening	31 mm	31 mm
Angolo di rotazione (libera)	Rotation angle (free wheel)	360°	360°
Peso	Weight		
Peso (senza sella)	Weight (without bracket)	241 kg	129 kg
Peso minimo + massimo escavatore ⁽¹⁾	Weight excavator min + max ⁽¹⁾	3000 ÷ 5000 kg	1300 ÷ 3000 kg
Idraulica	Hydraulics		
Pressione massima in entrata	Inlet pressure max	200 bar	200 bar
Pressione di esercizio	Working pressure	500 bar	200 bar
Portata massima	Inlet flow max	100 l/min	150 l/min
Prestazioni	Specs		
Forza massima in punta (ganasce completamente aperte)	Power max at the tips (jaws completely open)	440 kN	317 kN
Forza massima taglio tondino	Rebar cutting power	1400 kN	920 kN
Taglio tondino diam.max	Rebar cutting diam.max	30 mm	28 mm
Morso	Jaws depth	195 mm	202 mm
Tempo di chiusura (4)	Jaws closing time (4)	3 s (Q=70 l/min)	4 s (Q= 42 l/min)
Tempo di apertura (4)	Jaws opening time (4)	2,5 s (Q= 70 l/min)	3 s (Q= 42 l/min)

(1) Dipendente dalla capacità di carico dell'escavatore

(1) Depending on excavator lifting capacity

 La pinza idraulica mod. "430 DE T34 Regolabile", con un peso di soli 183 kg permette di demolire pareti in calcestruzzo di spessore variabile da 50 a 430 mm, grazie al sistema brevettato di regolazione delle ganasce

 Concrete crusher mod. "430DE T34 Adjustable Jaws" weighs 183 kg only and allows the demolition of concrete walls 50 to 430 mm thick, thanks to the new patented jaws adjusting system.



P
A
T
E
N
T

P
E
N
D
I
N
G

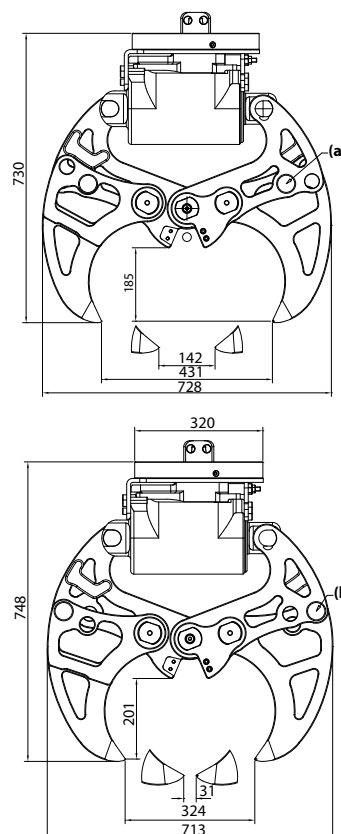

DEMOLIZIONE CONTROLLATA
CONTROLLED DEMOLITION

PINZA 430 DE T34 REGOLABILE
CRUSHER 430 DE T34 ADJUSTABLE JAWS
COD. 1.50.2139

PUNTALE SPECIALE PER FRANTUMAZIONE
OPTIONAL PULVERIZING TIP
COD.1.50.1563 (optional)

Dimensioni	Dimensions	1.50.2139
Altezza (senza sella)	Height (without bracket)	748 mm
Larghezza totale	Length	728 mm
Profondità	Width	322 mm
Apertura massima tra i puntali ⁽¹⁾	Jaws opening max ⁽¹⁾	431 mm
Apertura minima tra i puntali ⁽⁴⁾	Jaws opening min ⁽⁴⁾	31 mm
Angolo di rotazione (libera)	Rotation angle (free wheel)	360°
Peso	Weight	
Peso (senza sella)	Weight (without bracket)	183 kg
Peso minimo ÷ massimo escavatore ⁽⁶⁾	Weight excavator min ÷ max ⁽⁶⁾	1500 ÷ 5000 kg
Idraulica	Hydraulics	
Pressione massima in entrata	Inlet pressure max	200 bar
Pressione di esercizio	Working pressure	200 bar
Portata massima	Inlet flow max	150 l/min
Prestazioni	Specs	
Forza massima in punta ⁽¹⁾	Max power at the tips ⁽¹⁾	335 kN
Forza massima in punta ⁽²⁾	Max power at the tips ⁽²⁾	155 kN
Forza massima in punta ⁽³⁾	Max power at the tips ⁽³⁾	317 kN
Forza massima in punta ⁽⁴⁾	Max power at the tips ⁽⁴⁾	159 kN
Forza massima sul coltello ⁽⁵⁾	Cutting power ⁽⁵⁾	920 kN
Diametro tondino massimo tagliabile	Rebar cut max diam.	28 mm
Morso	Jaws depth	185 mm
Tempo di apertura / chiusura (Q= 42 l/min)	Opening / closing time (Q=42 l/min)	3 / 4 s

(1) Tutta aperta - pemi in posizione (a)
(2) Tutta chiusa - pemi in posizione (a)
(3) Tutta aperta - pemi in posizione (b)

(4) Tutta chiusa - pemi in posizione (b)
(5) In posizione intermedia
(6) Dipendente dalla capacità di carico dell'escavatore

(1) Fully open - pin in pos. (a)
(2) Fully closed - pin in pos. (a)
(3) Fully open - pin in pos. (b)

(4) Fully closed - pin in pos. (b)
(5) Middle position
(6) Depending from excavator lifting power

Cesoie da applicare a escavatori compatti con peso a partire da 15/18 q. Le macchine sono dotate di rotazione idraulica integrata e permettono il taglio di materiali metallici anche in aderenza ad una superficie (vedi foto 1). Indicata per cavi, funi, tubi, putrelle, travi metalliche ...

Cutters for mini excavators starting from the 15/18 q range (upon excavator lifting capacity). Designed to cut materials close to a vertical surface or laying down on the floor (see pict. 1). Fitted with built-in hydraulic rotator. Suitable for cables, ropes, pipes, joists, beams ...



CESOIA F200C CON LAME AD INSERTI INTERCAMBIABILI
CUTTER F200C WITH REPLACEABLE CUTTING EDGES
COD. 1.50.2380

CESOIA F250C CON LAME AD INSERTI INTERCAMBIABILI
CUTTER F250C WITH REPLACEABLE CUTTING EDGES
COD. 1.50.2446

CESOIA F300C CON LAME AD INSERTI INTERCAMBIABILI
CUTTER F300C WITH REPLACEABLE CUTTING EDGES
COD. 1.50.2552

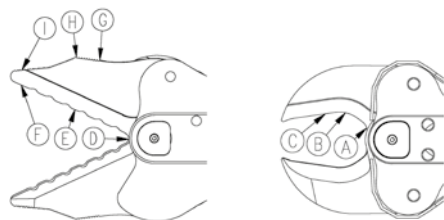

CESOIA MULTIUSO F450M
COMBI-CUTTER F450M
COD. 1.50.2445

Indicata per demolizioni in ambito industriale e nucleare
Suitable for industrial and nuclear demolition applications

Lama speciale con inserti intercambiabili
Special blade with replaceable cutting edges



		1.50.2380	1.50.2446	1.50.2552	1.50.2445
Dimensioni (senza sella)	Dimensions (without bracket)	1043x220x325 mm	1083x220x325 mm	1352x320x486 mm	1020x451x320 mm
Peso (senza sella)	Weight (without bracket)	178 kg	182 kg	310 kg	197 kg
Apertura lame in punta	Blade opening at the tips	205 mm	250 mm	300 mm	450 mm
Profondità lame max	Blade depth max	160 mm	225 mm	250 mm	250 mm
Forza di taglio	Cutting force	a 736 kN b 500 kN c 275 kN	a 736 kN b 500 kN c 275 kN	a 1060 kN b 598 kN c 481 kN	d 657 kN e 206 kN f 117 kN
Forza di divaricazione	Spreading force	/	/	/	g 294 kN h 156 kN i 88 kN
Angolo di rotazione	Rotation angle	360°	360°	360°	360°
Pressione entrata olio/portata	Inlet pressure/oil flow	200 bar - 150 l/min	200 bar - 150 l/min	200 bar - 150 l/min	200 bar - 150 l/min

CILINDRO SPACCA ROCCIA - 11 PISTONI
11 PISTON ROCK SPLITTER
COD.1.50.2495

CILINDRO SPACCA ROCCIA - 2 PISTONI
2 PISTON ROCK SPLITTER
COD.1.50.2496

CENTRALINA IDRAULICA RS1400
HYDRAULIC PUMP RS1400
COD.1.50.2575

DISTRIBUTORE A 3 USCITE
DISTRIBUTOR - 3 DELIVERIES
COD.1.50.2610

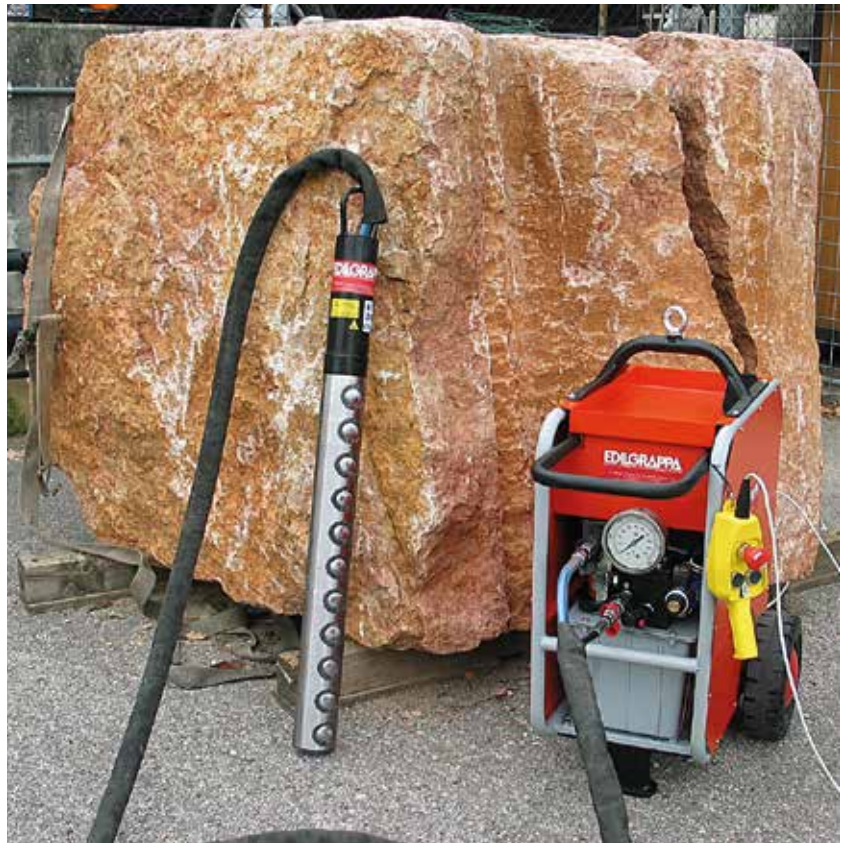

DEMOLIZIONE CONTROLLATA
 CONTROLLED DEMOLITION

I cilindri spaccaroc cia della EDILGRAPPA rappresentano un valido metodo alternativo all'impiego di esplosivi per la rottura e demolizione di blocchi in roccia o calcestruzzo di notevoli dimensioni, senza generare rumori, vibrazioni o proiezione di detriti nell'ambiente circostante.

I cilindri spaccaroc cia sono leggeri, potentissimi e azionati da una centralina idraulica a 1450 bar con motore elettrico monofase. Il foro di inserimento richiesto, facilmente praticabile con una carotatrice standard, varia da diam. 90 a diam. 200 mm

EDILGRAPPA rock splitting cylinders offer an alternative method for efficient splitting of hard rock boulders without the need for explosives, vibrations or fly rock.

Rock splitters are lightweight, powered by a compact electrically driven 1450 bar power pack and require either 90 or 200 mm dia. bores from a standard boring machine.



CILINDRO SPACCAROC CIA	ROCK SPLITTER	1.50.2495	1.50.2496
Modello	Model	11 pistoni/pistons	2 pistoni/pistons
Forza	Force	258 t / 1450 bar*	209 t / 1450 bar*
Peso	Weight	38,4 kg	47,2 kg
Dimensioni cilindro	Cylinder dimensions	Ø 83 mm	140x193 mm
Foro richiesto	Required bore	Ø 90 mm	Ø 200 mm
Lunghezza totale	Overall length	1.130 mm	710 mm
Lunghezza cilindro	Cylinder length	744 mm	250 mm
Portata / Oil flow 0,7 l/min			

 made in Italy

PROGETTATO E REALIZZATO INTERAMENTE IN ITALIA

Attrezzi per ricerca e soccorso in contesti urbani.

Gli attrezzi Edilgrappa della gamma MDC300/MDC360 hanno altissima potenza di taglio e divaricazione pur mantenendo peso e dimensioni contenuti. Le macchine sono completamente autonome ed indipendenti grazie alla motorizzazione integrata disponibile in tre versioni: a batteria, elettrica 230V o con motore a scoppio. Tutti i modelli sono dotati di testa orientabile, sistema di illuminazione a led e rispettano le norme EN13204:2004.

Cesoie e attrezzi multiuso portatili per interventi di soccorso; taglio di telai di veicoli e loro parti, tubi metallici, funi, cavi. Non necessitano di centralina idraulica.

CESOIA F150N T40 - 230V
CUTTER F150N T40 - 230V
COD. 1.50.2590

CESOIA F150N T40 - 120V
CUTTER F150N T40 - 120V
COD. 1.50.2591



180° Testa girevole a 180°
180° rotating head

 made in Italy

100% DEVELOPED AND MANUFACTURED IN ITALY

Urban search and rescue tools.

Edilgrappa sets new standards in Urban Rescue with its self-contained series of Cutters and Combi-Tools, independent from any hydraulic power remote source for a hose-free easy operation on site. Unparalleled commitment to quality of manufacturing, combined with unique design delivers high power and lightweight tools resulting in minimum effort and maximum efficiency in use. Rotating head, Star-grip actuator and LED lighting system complete the standard fittings of each tool. EN13204:2004 compliant.

Rescue portable cutters and combi-tools; suitable for car pillars, metal pipes, ropes, cables, ... cutting. No hydraulic pump required

ATTREZZO MULTIUSO MDC360 T40 - 230V
COMBI TOOL MDC360 T40 - 230V
COD. 1.50.2592

ATTREZZO MULTIUSO MDC360 T40 - 120V
COMBI TOOL MDC360 T40 - 120V
COD. 1.50.2593



180° Testa girevole a 180°
180° rotating head

CESOIA F150N T40 A BATTERIA 36V
CUTTER F150N T40 - 36V BATTERY OPERATED
COD. 1.50.2658



180° Testa girevole a 180°
180° rotating head

ATTREZZO MULTIUSO MDC360 T40 A BATTERIA 36V
COMBI TOOL MDC360 T40 - 36V BATTERY OPERATED
COD. 1.50.2634



180° Testa girevole a 180°
180° rotating head

Tutte le macchine a batteria hanno una batteria in dotazione. Per batterie supplementari, carica batteria ed altri accessori vedi pag. 42
All the battery tools are supplied with one battery. For spare batteries, charger and other accessories see page 42

CESOIA CESOIA F150N T40 - MOTORE A SCOPPIO
CUTTER F150N T40 - PETROL ENGINE
COD. 1.50.2602

ATTREZZO MULTIUSO MDC360 T40 - MOTORE A SCOPPIO
COMBI TOOL MDC360 T40 - PETROL ENGINE
COD. 1.50.2603



180° Testa girevole a 180°
180° rotating head



180° Testa girevole a 180°
180° rotating head

MOTORE A BENZINA 4 TEMPI 1 hp - 4-STROKE PETROL ENGINE 1 hp

CUTTING CAPACITY ACCORDING TO
UNI EN13204:2004 CATEGORIA H / CATEGORY H

MATERIALE MATERIAL	PROFILO PROFILE	MISURA mm SIZE mm
S235JR	●	Ø 30
S235JR	▬	110x10
S235JR	□	60x60x4
S235JR	▭	80x40x4
S235JR	○	Ø 76.1x4

La nuova serie di attrezzi per ricerca e soccorso include un innovativo sistema di illuminazione a LED, testa girevole e batteria agli Ioni di Litio ad alta efficienza.

New series of Rescue Tools features an innovative LED lighting system, rotating head and high efficiency Li-Ion battery.



C: 150 mm dalla punta / 150 mm from the tip
 B: 65 mm dalla punta / 65 mm from the tip
 A: 25 mm dalla punta / 25 mm from the tip

ATTREZZO DI SOCCORSO RESCUE TOOL		1.50.2590	1.50.2592	1.50.2591	1.50.2593	1.50.2658	1.50.2634	1.50.2602	1.50.2603
UNI EN13204:2004	UNI EN13204:2004	BC145H-20,4	CK41,2/360-H-20,5	BC145H-20,4	CK41,2/360-H-20,5	BC145H-20,9	CK41,2/360-H-21	BC145H-22,1	CK41,2/360-H-22,2
Apertura lame	Blade opening	145 mm	360 mm	145 mm	360 mm	145 mm	360 mm	145 mm	360 mm
Pressione	Pressure	700 bar	700 bar	700 bar	700 bar	700 bar	700 bar	700 bar	700 bar
Forza max di taglio nell'incavo	Max. Cutting force (at the blade recess)	40,2 t (394 kN)	40,2 t (394 kN)	40,2 t (394 kN)	40,2 t (394 kN)	40,2 t (394 kN)	40,2 t (394 kN)	40,2 t (394 kN)	40,2 t (394 kN)
Forza in trazione	Pulling force	/	8,8 t (86,3 kN)	/	8,8 t (86,3 kN)	/	8,8 t (86,3 kN)	/	8,8 t (86,3 kN)
Forza di schiacciamento (25 mm dalla punta)	Squeezing force (25 mm from the tip)	/	7,3 t (71,6 kN)	/	7,3 t (71,6 kN)	/	7,3 t (71,6 kN)	/	7,3 t (71,6 kN)
Forza divaricatore	Spreading force	/	A: 5,8 t B: 8,0 t C: 32,0 t	/	A: 5,8 t B: 8,0 t C: 32,0 t	/	A: 5,8 t B: 8,0 t C: 32,0 t	/	A: 5,8 t B: 8,0 t C: 32,0 t
Peso (senza batteria)	Weight (without battery)	19,9 kg	20,0 kg	19,9 kg	20,0 kg	17,8 kg	18,0 kg	21,6 kg	21,7 kg
Dimensioni mm (senza batteria)	Dimensions mm (without battery)	770x270 x260	760x270 x260	770x270 x260	760x270 x260	790x270 x400	850x270 x400	860x270 x260	840x270 x260

CESOIA F130N T30 - 230V
CUTTER F130N T30 - 230V
COD. 1.50.2598

CESOIA F130N T30 - 120V
CUTTER F130N T30 - 120V
COD. 1.50.2600



ATTREZZO MULTIUSO MDC 300 T30 - 230V
COMBI TOOL MDC 300 T30 - 230V
COD. 1.50.2599

ATTREZZO MULTIUSO MDC 300 T30 - 120V
COMBI TOOL MDC 300 T30 - 120V
COD. 1.50.2601



CESOIA F130N T30 A BATTERIA 18V
CUTTER F130N T30 - 18V BATTERY OPERATED
COD. 1.50.2521

ATTREZZO MULTIUSO MDC 300 T30 A BATTERIA 18V
COMBI TOOL MDC 300 T30 - 18V BATTERY OPERATED
COD. 1.50.2605



180° Testa girevole a 180°
180° rotating head

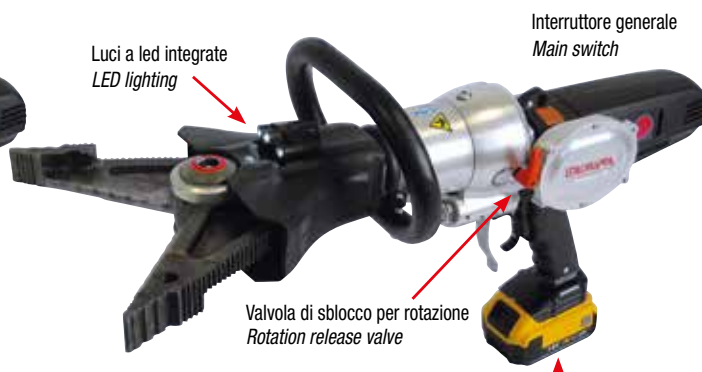

180° Testa girevole a 180°
180° rotating head

Nuova batteria con innesto a slitta
New slide-in battery

18V-4Ah Li-Ion battery powered

Tutte le macchine a batteria hanno una batteria in dotazione. Per batterie supplementari, carica batteria ed altri accessori vedi pag. 42
 All the battery tools are supplied with one battery. For spare batteries, charger and other accessories see page 42

CUTTING CAPACITY ACCORDING TO UNI EN13204:2004 CATEGORIA E / CATEGORY E

MATERIALE MATERIAL	PROFILO PROFILE	MISURA mm SIZE mm
S235JR	●	Ø 22
S235JR	■	80x8
S235JR	□	45x45x4
S235JR	▭	50x30x3

CUTTING CAPACITY ACCORDING TO UNI EN13204:2004 CATEGORIA F / CATEGORY F

MATERIALE MATERIAL	PROFILO PROFILE	MISURA mm SIZE mm
S235JR	●	Ø 24
S235JR	■	80x10
S235JR	□	50x50x4
S235JR	▭	60x40x3

**CESOIA F130N T30 A BATTERIA 36V
CUTTER F130N T30 - 36V BATTERY
OPERATED
COD. 1.50.2604**

**ATTREZZO MULTIUSO MDC 300 T30 A BATTERIA 36V
COMBI TOOL MDC 300 T30 - 36V BATTERY OPERATED
COD. 1.50.2595**



180° Testa girevole a 180°
180° rotating head

180° Testa girevole a 180°
180° rotating head

36V ADVANCED TECHNOLOGY

**CESOIA F130N T30 - MOTORE A SCOPPIO
CUTTER F130N T30 - PETROL ENGINE
COD. 1.50.2596**

**ATTREZZO MULTIUSO MDC 300 T30 - MOTORE A SCOPPIO
COMBI TOOL MDC 300 T30 - PETROL ENGINE
COD. 1.50.2597**



180° Testa girevole a 180°
180° rotating head

180° Testa girevole a 180°
180° rotating head

C: 150 mm dalla punta / 150 mm from the tip
B: 65 mm dalla punta / 65 mm from the tip
A: 25 mm dalla punta / 25 mm from the tip

MOTORE A BENZINA 4 TEMPI 1 hp - 4-STROKE PETROL ENGINE 1 hp

ATTREZZO DI SOCCORSO	RESCUE TOOL	1.50.2598	1.50.2599	1.50.2600	1.50.2601	1.50.2521	1.50.2605	1.50.2604	1.50.2595	1.50.2596	1.50.2597
UNI EN13204:2004	UNI EN13204:2004	AC130E-15,4	BK9/300-E-15,4	AS130E-15,4	BK9/300-E-15,4	AC130F-12,5	BK18/300-F-12,5	AC130F-12,5	BK18/300-F-12,5	AC130F-15,4	BK18/300-F-15,4
Apertura lame	Blade opening	130 mm	300 mm	130 mm	300 mm	130 mm	300 mm	130 mm	300 mm	130 mm	300 mm
Pressione	Pressure	550 bar	550 bar	550 bar	550 bar	550 bar	550 bar	550 bar	550 bar	550 bar	550 bar
Forza max di taglio nell'incavo	Max. Cutting force (at the blade recess)	32,6 t (320 KN)	32,6 t (320 KN)	32,6 t (320 KN)	32,6 t (320 KN)	33,7 t (330 KN)	33,7 t (330 KN)	33,7 t (330 KN)	33,7 t (330 KN)	33,7 t (330 KN)	33,7 t (330 KN)
Forza in trazione	Pulling force	/	8,9 t (87 KN)	/	8,9 t (87 KN)	/	8,0 t (78,5 KN)	/	8,0 t (78,5 KN)	/	8,0 t (78,5 KN)
Forza di schiacciamento (25 mm dalla punta)	Squeezing force (25 mm from the tip)	/	7,3 t (71 KN)	/	7,3 t (71 KN)	/	6,5 t (63,8 KN)	/	6,5 t (63,8 KN)	/	6,5 t (63,8 KN)
Forza divaricatore	Spreading force	/	A: 4,5 t B: 5,9 t C: 20,0 t	/	A: 4,5 t B: 5,9 t C: 20,0 t	/	A: 4,6 t B: 6,0 t C: 28,0 t	/	A: 4,6 t B: 6,0 t C: 28,0 t	/	A: 4,6 t B: 6,0 t C: 28,0 t
Peso (senza batteria)	Weight (without battery)	15,4 kg	15,4 kg	15,4 kg	15,4 kg	12,5 kg	12,5 kg	12,5 kg	12,5 kg	15,4 kg	15,4 kg
Dimensioni mm (senza batteria)	Dimensions mm (without battery)	670x240 x250	690x240 x250	670x240 x250	690x240 x250	690x240 x360	690x240 x360	690x240 x360	690x240 x360	720x250 x250	730x250 x250

APPLICAZIONI U.S.A.R.
URBAN SEARCH AND RESCUE

**CESOIA MU16 A BATTERIA con interruttore generale
MU16 CORDLESS CUTTER with main switch
COD. 1.50.2547**



**VERSIONE PER IL SOCCORSO
RESCUE VERSION**

CESOIA	CUTTER	MU16 1.50.2547
Taglio Ø	Cut Ø	16 mm R=70 Kg/mm ² 21 mm R=45 Kg/mm ²
Tensione	Voltage	18V - 4Ah
Potenza idraulica	Hydraulic power	14 ton/560 bar
Peso con batteria al Litio	Weight including Lithium ion battery	8,6 kg
Dimensioni	Dimensions	490x395x135 mm

**COD. 1.50.2524
CESOIA A BATTERIA SILVERCUT 20 con interruttore generale
SILVERCUT 20 CORDLESS CUTTER with main switch**



**VERSIONE PER IL SOCCORSO
RESCUE VERSION**

CESOIA	CUTTER	SILVERCUT 20 1.50.2524
Dimensioni	Dimensions	500x320x100 mm
Peso con batteria al Litio	Weight including Lithium ion battery	9,4 kg
Potenza idraulica	Hydraulic power	19 ton
Taglio Ø	Cut Ø	20 mm R=70 Kg/mm ²
Tensione	Voltage	18V - 4Ah
Pressione	Pressure	bar 550

**MARTINETTO TELESCOPICO A BATTERIA 36V
TELESCOPIC RAM 36V BATTERY
COD. 1.50.2370**



MARTINETTO TELESCOPICO	TELESCOPIC RAM	1.50.2370
Peso senza batteria al Litio	Weight excluding Lithium ion battery	16,1 kg
Lunghezza (tutto chiuso / tutto aperto)	Length (completely closed / fully open)	290 mm/573 mm
Estensione 1° stelo / 2° stelo	Stroke 1 st plunger / 2 nd plunger	160 mm/123 mm
Potenza idraulica 1° stelo / 2° stelo	Hydraulic power 1 st plunger / 2 nd plunger	21,8 t/7,9 t
EN 13204		TR214/160-77,5/123-17,4

**PROLUNGA L = 250mm / EXTENSION L = 250mm
COD. 1.50.2440**

**PROLUNGA L = 450mm / EXTENSION L = 450mm
COD. 1.50.2441**

Grande potenza e versatilità di impiego grazie all'assenza di tubazioni idrauliche o cavi elettrici di alimentazione. Rapida apertura dell'attrezzo nel secondo stadio e massima potenza nel primo per un efficace controllo della fase di spinta. Indicato per applicazioni USAR - estricazione da veicolo - applicazioni industriali.

Self contained, powerful and versatile - hoses and electric cables free. Fast opening in the 2nd stage and maximum power and control in the 1st stage. Suitable for vehicle extrication, USAR and industrial applications.

Tutte le macchine a batteria hanno una batteria in dotazione. Per batterie supplementari, carica batteria ed altri accessori vedi pag. 42
All the battery tools are supplied with one battery. For spare batteries, charger and other accessories see page 42

	Batteria 18V al Litio 4,0 Ah con indicatore di carica, peso 630 g		1.40.598
	<i>Battery 18V Lithium ion 4,0 Ah with led charge indicator, weight 630 g</i>		
	Batteria 18V al Litio 2,0 Ah peso 690 g		1.40.560
	<i>Battery 18V Lithium ion 2,0 Ah weight 690 g</i>		
	Batteria 36V al Litio 4,0 Ah con indicatore di carica, peso 1250 g		1.40.1000
	<i>Battery 36V Lithium ion 4,0 Ah with led charge indicator, weight 1250 g</i>		
	Compatibile con versione a 2,2 Ah <i>Compatible with 2,2 Ah version</i>		
	Batteria 18V NiMH 2,6 Ah peso 990 g		1.40.557
	<i>Battery 18V NiMH 2,6 Ah weight 990 g</i>		
	Carica batteria con innesto a slitta 18V Litio	230V	1.40.614
	<i>Charger for sliding battery 18V Lithium ion</i>	120V	1.40.633
	Carica batteria per batteria 18V NiMH e Litio	230V	1.40.561
	<i>Charger for battery 18V NiMH & Lithium ion</i>	120V	1.40.562
	Carica batteria per batteria 18V NiMH e Litio	12V	1.40.563
	<i>Charger for battery 18V NiMH & Lithium ion</i>		
	Carica batteria per batteria 36V al Litio	230V	1.40.994
	<i>Charger for battery 36V Lithium ion</i>	120V	1.40.627

	Cinghia a spalla con gancio Adatto a serie MDC300/MDC360		1.50.2420
	<i>Carrying strap with quick release Suitable for MDC300/MDC360</i>		
	Corpetto con gancio Adatto a serie MDC300/MDC360		1.50.2421
	<i>Shoulder band with quick release Suitable for MDC300/MDC360</i>		
	Imbragatura di trasporto per attrezzi con impugnatura inferiore		1.50.2422
	<i>Carrying harness for pistol grip tools</i>		
	Imbragatura di trasporto per attrezzi con impugnatura superiore		1.50.2423
	<i>Carrying harness for top handle tools</i>		
	Kit catena composto da 2 puntali, catena 1,5 m + 3 m e ganci accorciatori Adatto a serie MDC300		1.50.2426
	<i>Pulling chain set consisting of 2 tips, 1,5 m + 3 m chains and shortening hooks Suitable for MDC300</i>		
	Kit catena composto da 2 puntali, catena 1,5 m + 3 m e ganci accorciatori Adatto a serie MDC360		1.50.2427
	<i>Pulling chain set consisting of 2 tips, 1,5 m + 3 m chains and shortening hooks Suitable for MDC360</i>		



EDILGRAPPA



SINCERT



Via Callesello, 4
31030 Borso del Grappa (TV)
Italy
Tel. +39 0423 910122
Fax +39 0423 542122
www.edilgrappa.com
cut@edilgrappa.com