

EDILGRAPPA

CE

CORDLESS SHEAR MU16 18V Li-Ion WITH ADJUSTABLE HEAD



©

No part of this manual may be reproduced or translated without the written permission of the owner. The information and illustrations contained in this manual are purely indicative. Edilgrappa S.r.l. reserves the right to modify the machine without notice.

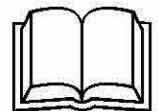

USE AND MAINTENANCE INSTRUCTIONS

ELECTRIC SHEAR

AVAILABLE IN THE FOLLOWING VERSIONS:

- 18V DIRECT CURRENT MOTOR

FIXED HEADS AVAILABLE	NAME OF MACHINE	P/N
CORDLESS	SHEAR MU16 18V Li-Ion WITH ADJUSTABLE HEAD	1.50.2752

CONTENTS

Chap. 0 GENERAL INFORMATION	6
0.01 FOREWORD	6
0.02 CONDITIONS OF SALE AND WARRANTY	6
0.03 SPECIAL SYMBOLS	7
0.04 SAFETY AND DANGER STICKERS - CE PLATE	8
0.05 LIST OF ACCESSORIES INCLUDED IN THE SUPPLY	9
Chap. 1 REFERENCE LEGISLATION	9
1.01 GENERAL	9
Chap. 2 GENERAL SAFETY WARNINGS FOR ELECTRICAL TOOLS	9
2.01 SAFETY OF THE WORK STATION	9
2.02 ELECTRICAL SAFETY	11
2.03 PERSONAL SAFETY	11
2.04 USE AND MAINTENANCE OF ELECTRIC TOOLS	12
2.05 ASSISTANCE	12
2.06 SPECIFIC OPERATING INSTRUCTIONS	12
Chap. 3 DESCRIPTION OF MACHINE	13
3.01 MACHINE COMPONENTS	13
Chap. 4 TECHNICAL SPECIFICATIONS	14
4.01 HYDRAULIC, MECHANICAL AND ELECTRICAL SPECIFICATIONS	14
Chap. 5 DELIVERY, COMMISSIONING AND SET-UP	15
5.01 DELIVERY	15
5.02 CHARGING THE BATTERY	15
5.03 INSTALLING THE BATTERY	16
5.04 COMMISSIONING	17
5.05 EQUIPMENT OPERATION	17
5.05.01 START-UP	17
5.05.02 CUTTING PHASE	17
5.05.03 ADJUSTING THE HEAD	18
5.06 MANUAL RETURN LEVER	19
5.07 RUNNING DOWN THE BATTERY	19
5.4 FORESEEN USE AND RESIDUAL RISKS	20
5.5 SAFETY DEVICES	20
Chap. 6 ROUTINE MAINTENANCE	21
6.01 CHANGING AND TOPPING UP THE OIL	22
6.02 CHECKING SCREWS	23
6.03 CHECKING BLADES	24
6.04 HYDRAULIC COMPONENTS	25
6.04.01 CLEANING THE PISTON	25
6.04.02 ADJUSTING THE STROKE OF THE UPPER BLADE	25
6.04.03 MANUAL RETURN VALVE DOES NOT CLOSE	26
6.04.04 MAX. PRESSURE VALVE INCORRECTLY ADJUSTED	26
6.05 MAIN CHECKS ON THE MOTOR	26
Chap. 7 TROUBLESHOOTING	26

7.01 GENERAL	26
7.02 TROUBLESHOOTING THE MOTOR	26
7.03 TROUBLESHOOTING THE HYDRAULIC COMPONENTS	27
Chap. 8 STORAGE AND RESTARTING	28
8.01 STORAGE	28
8.01.01 ELECTRIC MOTOR	28
8.01.02 CYLINDER AND HYDRAULIC COMPONENTS	29
8.02 RESTARTING	29
Chap. 9 DISPOSAL.....	29
Chap. 10 SPARE PARTS AND ACCESSORIES CATALOGUE.....	30
10.01 ORDERING INFORMATION	30
Chap. 11 DECLARATION OF CONFORMITY	35

Chap. 0 GENERAL INFORMATION

0.01 FOREWORD

This manual was drawn up to allow customers to optimise machine operation and should therefore be read in its entirety before use.

The following chapters contain useful use and maintenance information. **Knowledge and scrupulous observance of current occupational safety and plant engineering legislation is a fundamental requirements for correct use.** Cost-saving and regular and safe machine operation can be achieved through rational use and careful maintenance. In case of faults or inefficient operation, call in specialist staff and order original spare parts from the maker, its technical assistance network and its technicians.

This manual forms an integral part of the machine. Users must scrupulously follow all the instructions it contains.

As the contents of this manual may change over time following modifications to reference legislation and/or technical improvements deriving from technological developments, its validity is determined from the date it was issued.

Pursuant to EEC Directive 85/374, the machine maker is not liable for harm to people, property or animals deriving from the negligent use or installation of the machine or failure to observe legislation. The maker also declines all liability if the machine is tampered with, if original parts are modified or if the machine is damaged due to incorrect storage or transport operations.

In thanking you for the preference shown to our company, please rest assured we will do our utmost to enhance the efficiency of our service and improve the quality and performance of our products and accessories according to our know-how and your requirements.

0.02 CONDITIONS OF SALE AND WARRANTY

Starting from the date of delivery, the Maker grants the purchaser a 24 (twenty-four) month warranty covering product quality and performance as follows:

The warranty certificate must be compiled and returned to the Maker within 10 days from the date of delivery of the product.

The warranty covers faulty spare parts but does not comprise labour and any transport costs.

Repairs will only be made under warranty if manufacturing faults are found or if the quality of the material is poor.

The warranty shall automatically expire if the fault is caused by:

- a fault in the electricity supply
- tampering, repairs or modifications without our permission
- improper use of the machine
- prolonged use without observing the pauses required for cooling
- forcing or wear caused by prolonged use
- no maintenance
- use on excessively hard or thick material
- incorrect positioning during processing.

Machine downtime for repairs under warranty is up to 10 days unless written notification to the contrary is received.

No damage deriving from machine downtime or damage caused to third parties shall be recognised. The following product is compliant with Italian Ministerial Decree of 9/10/80.

0.03 SPECIAL SYMBOLS

A brief legend indicating the most important symbols used in this manual is shown below.



ATTENTION DANGER: highlights situations or problems that could lead to injury or death.

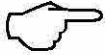

IMPORTANT: highlights situations and problems connected with the efficiency of the machine that do not affect personal safety.

BEFORE WORKING ON THE MACHINE, CAREFULLY READ ALL THE INSTRUCTIONS, ESPECIALLY THOSE CONTAINED IN BOXES.

- “OPERATOR”:** A person suitably trained and authorised to operate, adjust, clean and transport the machine.
- “MAINTENANCE PERSON”:** A person trained and authorised to perform routine maintenance on the machine and replace certain components.
- “MACHINE”:** The equipment described in this manual
- “ELECTRIC TOOL”:** Used in the safety precautions, it is a more general definition of the machine in question as it refers to mains-powered electric tools (with cable) or battery-powered electric tools (cordless).

0.04 SAFETY AND DANGER STICKERS - CE PLATE

Position of plate and safety and danger stickers on the machine:

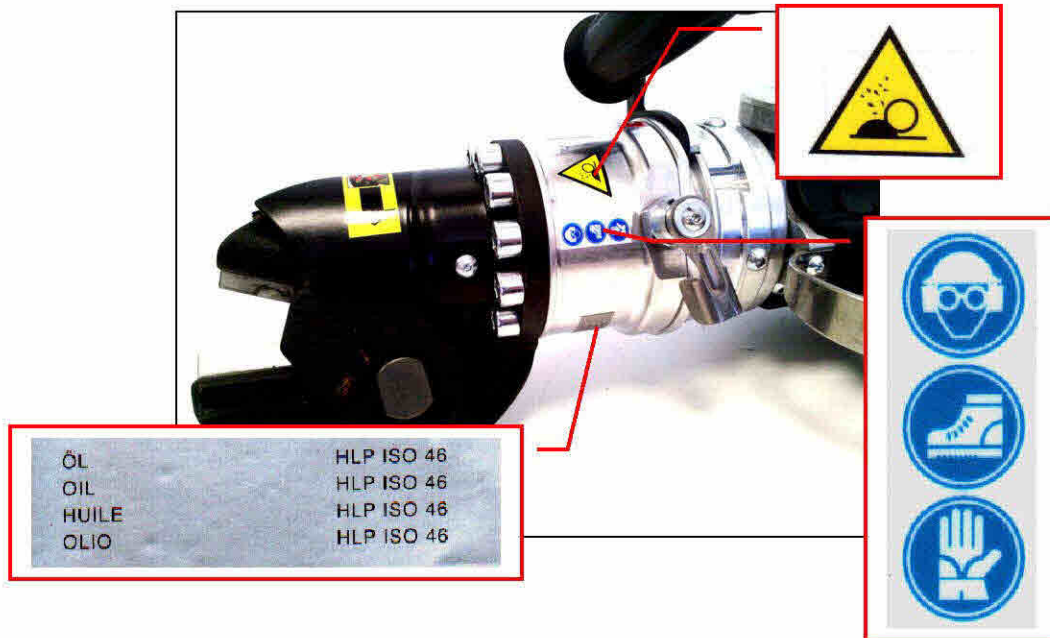
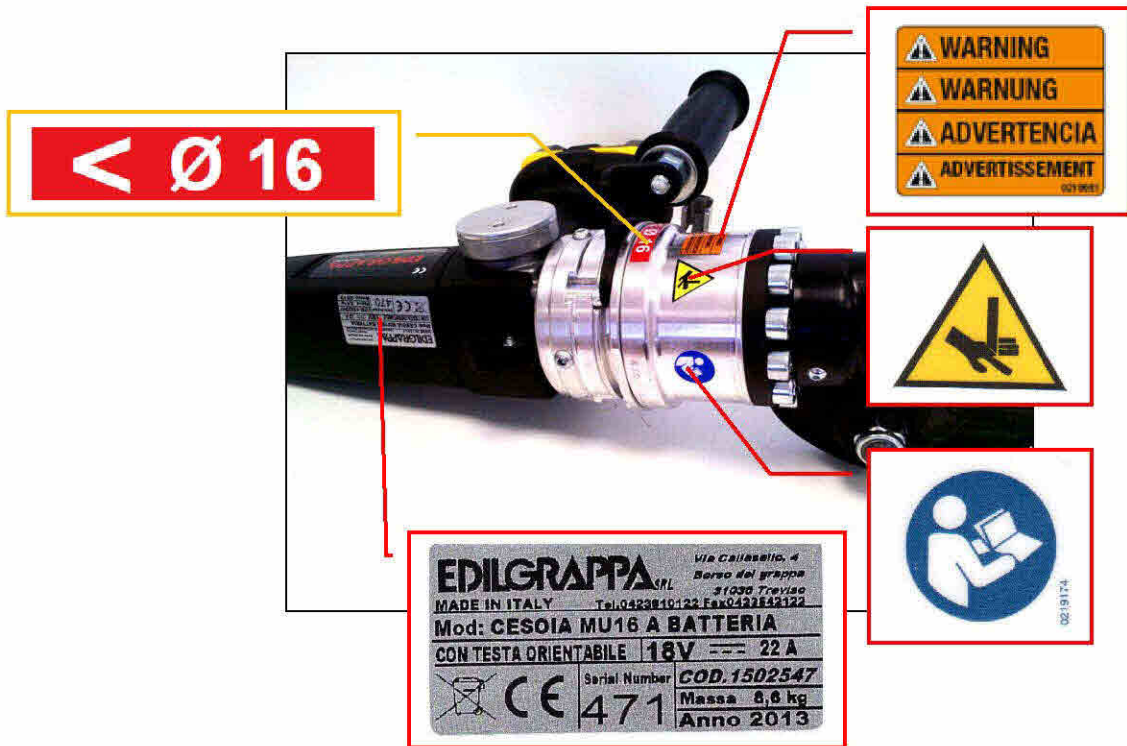

Observe the warnings on the plates and stickers. Failure to do so could lead to injury or death. Make sure the plates and stickers are attached and legible. If not, apply them or request the maker for replacements.

0.05 LIST OF ACCESSORIES INCLUDED IN THE SUPPLY

- Case
- Use and maintenance instructions
- Declaration of conformity
- Warranty certificate
- Emergency key

Chap. 1 REFERENCE LEGISLATION

1.01 GENERAL

This series of machines corresponds to the definition of machine to be found in the Machinery Directive 2006/42/EC. The electrical parts are compliant with the European “low voltage” directive 2006/95/EC.

Noise levels were measured according to CEI EN 60745-1 and CEI EN 60745-2-8 (no-load).

OPERATORS MUST BE PROVIDED WITH SUITABLE PERSONAL PROTECTIVE EQUIPMENT.

Vibration levels were measured according to CEI EN 60745-1 and EN ISO 5349.

The raw materials used and their processing during the product manufacturing cycle do not contain any toxic or hazardous materials referred to in Community Directives n° 2000/53/EC, n° 2011/65/EC (RoHS directive) and n° 2002/96/EC, as indicated in the relative raw materials test certificate.

Chap. 2 GENERAL SAFETY WARNINGS FOR ELECTRICAL TOOLS

Concerning the battery charger, consult the relative use and maintenance manual.

Failure to observe these warnings and instructions can lead to electrocution, fire and/or serious personal injury.

Keep all warnings and instructions for future consultation.

Scrupulously observe the instructions contained in this manual and keep it in a suitable and accessible place. Keep the manual for future consultation until the machine is demolished. If the machine is sold, the manual must be given to the new owner.

Given the intended use and, therefore, the environments in which these tools can be used, scrupulously follow the instructions shown below.

2.01 SAFETY OF THE WORK STATION

The workplace must comply with current occupational health and safety regulations.

Untidy or badly lit areas can cause accidents.

a) Keep the work area clean and well-illuminated.

Electric tools generate sparks that can ignite gas and powders.

b) Do not use electric tools in explosive atmospheres, for example, in the presence of liquids, gas or flammable powders. Do not use on live electric lines, on pressure vessels or ducts, on vessels containing corrosive and/or toxic substances.



- Do not use naked flames or the like near the machine.
- Do not use the machine in areas subject to the risk of fire or explosion.

Foresee the possible consequences deriving from the use of the equipment in order not to be involved or involve other people in potentially hazardous situations.

c) Keep children and observers at a safe distance when using electric tools. **Any distractions can lead to loss of control.**

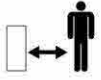

- Ensure other people remain at a safe distance when the machine is working (at least 5 metres). Cordon off the work area.
- Stop the machine if people and/or animals enter the work area.
- Periodically clean the machine and remove foreign bodies that could damage it or injure the operator.

2.02. ELECTRICAL SAFETY

Concerning the battery charger, consult the relative use and maintenance manual.

2.03 PERSONAL SAFETY



- The operator is responsible for safe machine operation.
- Only allow the machine to be used by suitably trained and authorised adults.

A When using an electric tool, operators must be alert, observe what they are doing and work with care. Do not use electric tools when tired or under the effect of drugs, alcohol or medicinals.

A moment of distraction when using electric tools can cause serious personal injury.

B Use personal protective equipment. Always protect the eyes.

Protective equipment, such as dust masks, non-slip safety shoes, helmets or ear protectors, used in suitable circumstances, will reduce the risk of personal injury.

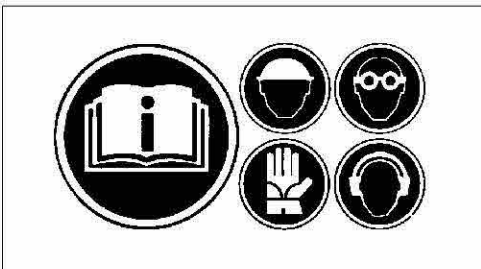

C Do not switch the tool on accidentally. Make sure the switch is in the "OFF" position before connecting the tool to the mains power supply and/or batteries before picking it up or before moving it.

If electric tools are transported while the operator's finger is on the switch or if they are connected to the mains power supply with the switch in the "ON" position, accidents may occur.

D Remove all adjustment tools and wrenches before switching on the tool.

A wrench or tool fixed to a rotating element of an electric tool can cause personal injury.

E Do not lose your balance. Always stay in a stable and balanced position. *This improves tool control in unforeseen situations.*

F Wear suitable clothing. Do not wear loose clothing or jewellery. Keep hair, clothes and gloves away from moving parts.

Loose clothing, jewellery or long hair can get caught up in moving parts.

G If devices for connection to dust extraction and capture systems are present, make sure they are correctly used and connected. *The use of these devices can reduce dust-related risks.*



Before using the machine, make sure the safety devices are in place and in good condition; replace the guards immediately if they develop faults or suffer damage.

2.04 USE AND MAINTENANCE OF ELECTRIC TOOLS

- a) Do not force the tool. Use the right tool for the job to be done. *Using the correct tool will assure improved and safer performance if used at the speed it was designed for.*
- b) Do not use the tool if it cannot be switched on and off from its switch. *Any tool that cannot be controlled with the switch is dangerous and must be repaired.*
- c) Disconnect the tool from the mains power supply and/or batteries before adjusting it, changing accessories and putting it down. *These preventive safety measures reduce the risk of the tool being operated by accident.*
- d) Keep electric tools out of the reach of children and do not allow inexperienced people or people who have not read these instructions to use them. *Electric tools are dangerous in the hands of inexperienced users.*
- e) Perform maintenance on electric tools. Check for misaligned or jammed moving parts, broken components and any other condition that could make the electric tool work incorrectly. If damaged, have the electric tool repaired before using it again. *Many accidents derive from poor maintenance.*
- f) Keep cutting tools sharp and clean. *Suitably maintained cutting tools with sharp edges are less likely to jam and are easier to control.*
- g) Use the cutting tool, accessories and heads, etc. in accordance with these instructions, bearing in mind operating conditions and the type of work to carry out.



The unforeseen use of electric tools could give rise to hazardous situations.

2.05 ASSISTANCE

Electric tools may only be serviced by a qualified technician using original spare parts. *This ensures that they are kept in safe operating conditions.*

2.06 SPECIFIC OPERATING INSTRUCTIONS



IMPORTANT: When the oil temperature exceeds approx. 70°C, turn off the tool until the oil cools down.

- As the machine has been designed for non-continuous use, sufficiently long pauses must be made to allow the oil to cool to room temperature.

FOR UNINTERRUPTED AND PROLONGED USE, CONSULT THE MAKER

- Make sure the cooling circuits are unobstructed and the cooling surfaces clean in order to avoid dangerous overheating.

- Do not alter the calibration of the safety devices (maximum pressure valves).
- Do not service or clean the machine, or replace tools or guards while it is operating and with the power plug inserted in a power socket.
- Periodically check the conditions of the power cable and, if damaged, replace it with an original spare.



Do not remove the guards installed on the equipment and accessories.

- Pursuant to the standards indicated and followed by the maker, the equipment components that also perform a safety function (insulators, guards, etc.) must not be repaired but replaced with original spare parts.
- Always make sure there are no traces of oil, grease or corrosive substances on the equipment (especially the grips).
- Use a damp cloth and soapy water to clean plastic components.



DO NOT USE PETROL OR THINNER TO CLEAN THE MACHINE.

- Store electric tools in a dry place that can only be accessed by authorised staff.

Chap. 3 DESCRIPTION OF MACHINE

3.01 MACHINE COMPONENTS

This machine is fitted with a direct current motor.

The equipment comprises:

- a motor, - a hydraulic pump driven by the motor, - a rod actuator (piston) driven by the oil pressured by the pump, - a fixed head with tool.

Fig. 1 shows the main parts of the machine fitted with a motor, in particular:

1. cylinder with hydraulic components
2. head with tool
3. release lever or double-acting lever
4. grip with start switch
5. battery with residual charge indicator
6. electric motor
7. start button
8. oil cap
9. side grip

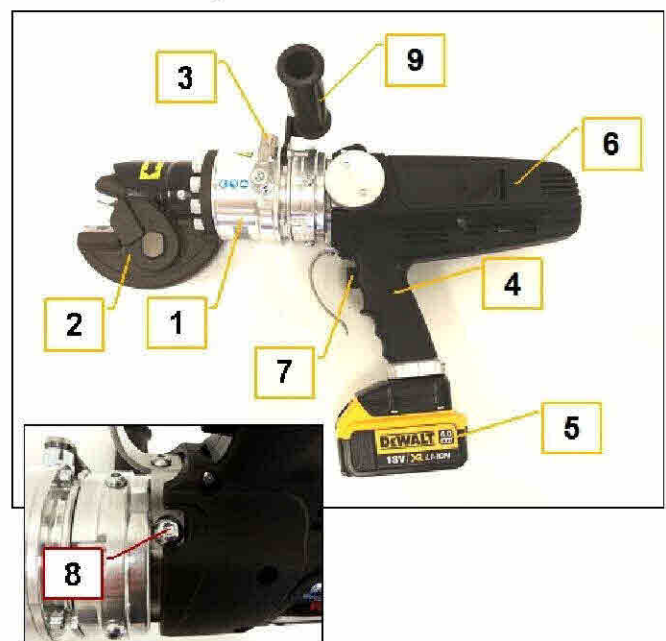



Fig.1

Chap. 4 TECHNICAL SPECIFICATIONS

4.01 HYDRAULIC, MECHANICAL AND ELECTRICAL SPECIFICATIONS

Maximum cutting size and characteristics of material [mm and daN/mm ²]	16 mm / R = 65 daN/mm ²
Maximum output force from rod [t]	14
Maximum operating pressure [bar]	560
Dimensions: Length X Width X Height [mm]	486 x 185 x 356
Weight (with battery inserted) [kg]	9.2
Guaranteed no-load LwA sound level (CEI EN 60745-1 and CEI EN 60745-2-8) [dB]	93
No-load operator Lpa (CEI EN 60745-1 and CEI EN 60745-2-8) [dB]	82
Vibrations when cutting diam. 16 mm rod (CEI EN 60745-1 and EN ISO 5349)	4.45 m/s ²
DRIVE SPECIFICATIONS	
Input voltage [V]	18 
Current type	Direct
Rated input current [A]	22
Insulation class	III
Electrical power [W]	450
CHARACTERISTICS OF BATTERY (Code: 140.01004)	
Nominal voltage [V]	18
Charge capacity [Ah]	5.0
Current type	
Materials used for elements	Li-Ion
Dimensions H X Length [mm]	65 X 110
Weight [kg]	0.62

Chap. 5 DELIVERY, COMMISSIONING AND SET-UP

5.01 DELIVERY

The machine is normally shipped and delivered inside a special hard case, well secured and in a stable position. All materials shipped are checked prior to delivery.

*Upon receipt, check the machine for any damage (breakages or major denting) caused during transport. If any damage is found, inform the forwarder immediately and write **"Accepted with reservations"** on the transport document.*



In the event of damage, send a written complaint to the forwarder within 8 days of receipt.

Promptly inform Edilgrappa s.r.l. if major damage, caused during transport, is found upon receipt, or if any parts are missing.

It is also necessary to check the delivered materials against the detailed shipping list.

The machine can be moved easily both when it is inside its special rigid case, using the upper handle, and by gripping its upper or lower handle.



Loads must be moved in compliance with current occupational safety regulations.

After use, put the machine back into its case or place it on a stable surface, making sure this can withstand its weight.

5.02 CHARGING THE BATTERY

Refer to the battery charger use and maintenance manual.

Charge the battery before use as follows.

1- connect the battery charger cable to a socket.

2- push the battery down to the bottom of the guides. (fig. 2)

If this is done correctly the red LED at the front shines, indicating that the battery is under rapid charging. Recharging times vary according to the charge status of the battery according to the data indicated in the technical specifications.

3- Remove the battery from the appliance when it indicates that charging is ended.

4- Disconnect the power cable of the appliance after use.

5- Handle the appliance with care, do not knock it and separate the battery from the appliance if it is not powered by the mains power supply.



Fig. 2

ATTENTION:

- Only recharge the battery under surveillance and do not leave the charger unguarded.
- Never attempt to connect another type of battery to the connection terminals as this can irreparably damage the battery charger.
- Even if the battery remains under charge after the red LED turns off, it continues to be charged at a low maintenance current without suffering any damage.
Keep the battery in maintenance for at least an hour in order to mix the chemical compounds of the battery and improve their diffusion, thus lengthening its lifetime.

5.03 INSTALLING THE BATTERY

The type of battery used on these machines is provided with residual charge control.

This system consists of a button (see ref. A in Fig.3) and a series of three leds (see ref. B in fig.3).
When the button is pressed the leds are lit, indicating the charge status.

If the leds do not light up the battery is completely flat.

Before connecting the battery, check the charge status.

Connect the battery to the shear using the guides in order to achieve a good electrical contact. Fig. 3

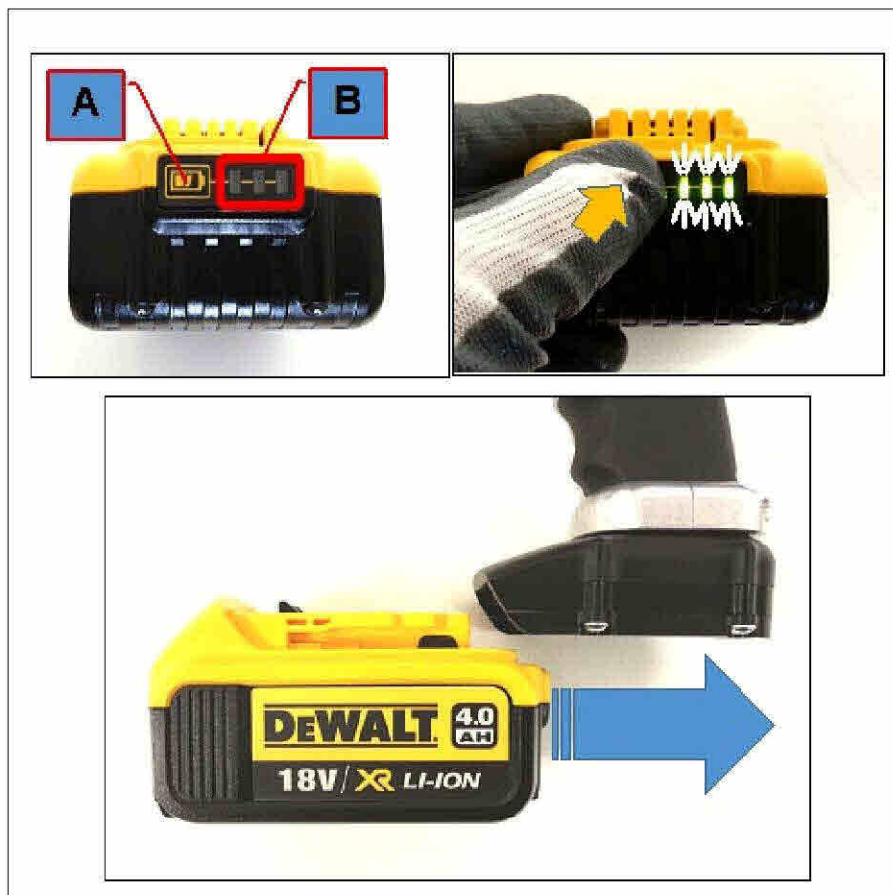

Fig. 3

5.04 COMMISSIONING

The only controls to perform concern:

- Machine integrity:

make sure that nothing happened during transport that could damage the insulation or mechanical parts. Make sure that the manual check valve is closed (paragraph 5.05).

- Completeness of supply:

check that all the supplied accessories are fitted (battery charged and installed).

- Oil level:

check the oil level and top up if necessary as per the instructions.

Before loosening the oil cap carefully read the instructions in chapter 6.

5.05 EQUIPMENT OPERATION

5.05.01 START-UP

After installing the battery press the on/off switch to start the machine.

5.05.02 CUTTING PHASE

Position the blade perpendicular to the axis of the work piece (fig. 4).



IMPORTANT: *Position the blade so as to minimise the cutting thickness.*

Non-perpendicular blade positions with respect to the workpiece increase cutting thickness.

If the cutting thickness is greater than the limit established for the tool its blades may break.

After correctly positioning the blade on the workpiece, press the start button and hold it down until cutting has been completed.

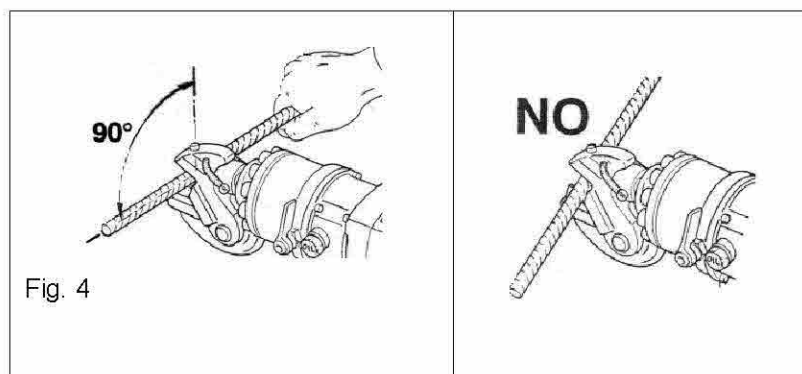

5.05.03 ADJUSTING THE HEAD

The head of this machine can be freely adjusted (rotated by 360°) to help the operator during positioning and subsequent cutting.

To adjust the head, simply turn the handle (ref. 1 in fig. 4A), as indicated by the arrows.

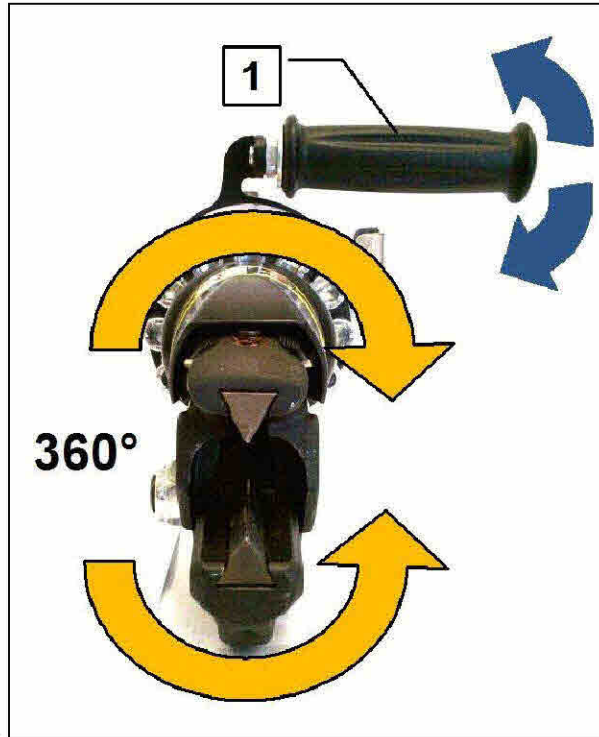
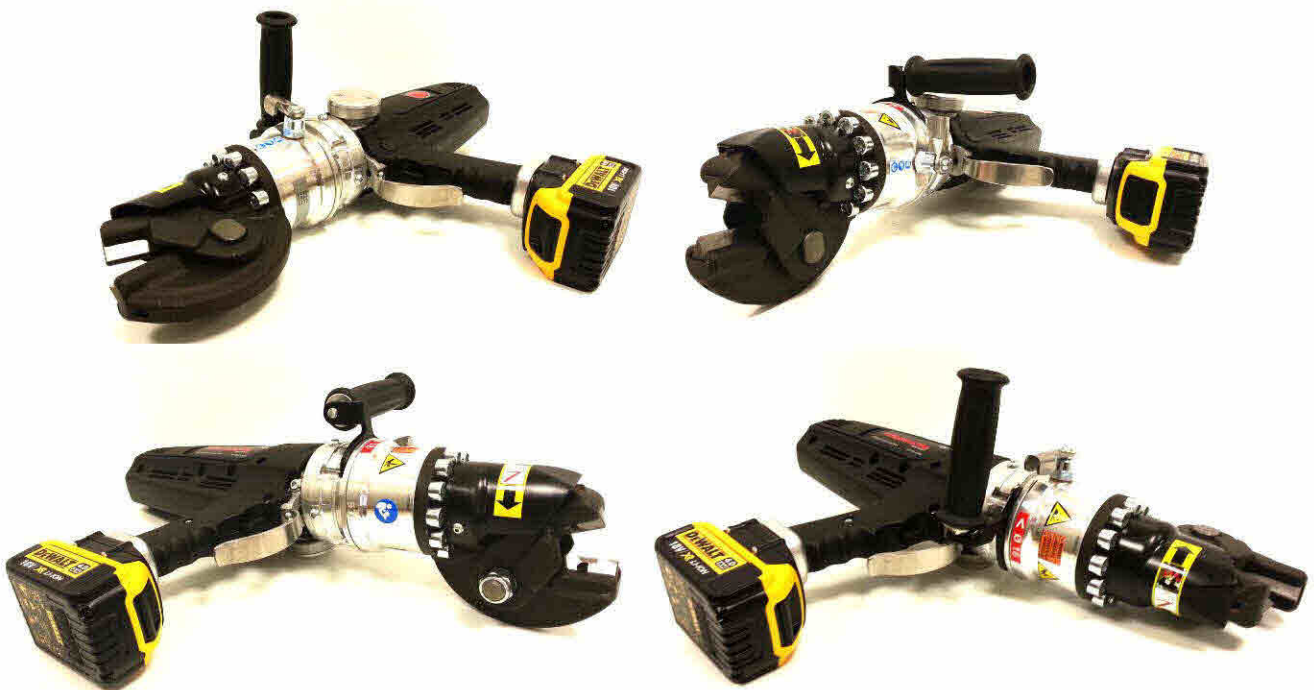

Fig. 4A





Adjusting the head with the tool disconnected and not working. Hold the grip (ref. 1 in fig. 4A) and handle (ref. 4 in fig. 1) firmly, without touching the on/off button, and move the head to the required position.

5.06 MANUAL RETURN LEVER

The manual return lever has two positions (see fig. 5)

- Position 1: valve closed. The piston work and return stroke takes place automatically.
- Position 2: valve open. To interrupt the work stroke or in case of emergency move the lever to position 2 to return the piston to its home position.

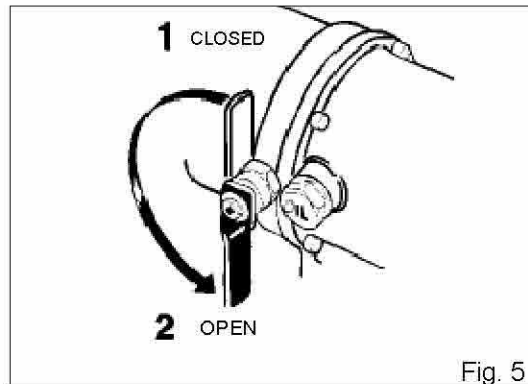

IMPORTANT: *If the machine does not work make sure the manual return lever is in position 1.*

5.07 RUNNING DOWN THE BATTERY

Use the machine until you can begin to hear a decrease in motor performance.
Do not use the battery any further so as not to ruin it, reduce its useful lifetime or overheat it.

Charge the battery before it runs down completely.
Wait for it to cool down before charging.

5.4 FORESEEN USE AND RESIDUAL RISKS

The machine must only be used to cut items in metal, such as electrowelded mesh, round bars, chains, padlocks, etc...in the building trade, industry and for emergency/rescue purposes. Maximum cutting diameter is 16 mm and the unit tensile strength of the material (steel) must not be greater than 640 N/mm². Do not use the machine to cut sheet steel or other items not mentioned above.

Any use other than that expressly indicated shall be considered as improper and therefore not permitted. Edilgrappa S.r.l. declines all liability for any improper use of the machine and for any modification or change made to it.

Operators must observe the instructions in this manual in order to minimise the risk of accidents. In particular, they must pay attention when working in conditions that could cause:

- Possible burns from overheated metal parts;
- Injury due to incorrect positioning or inadequate lifting or moving;
- Injury caused by splinters discharged from the work piece.

People remaining in the vicinities of the machine while it is working are subject to the following risks:

- flying debris (dangerous objects, etc...);

Hand/arm vibration. Standard applied: EN ISO 5349

The mechanical vibrations transmitted to the hands and arms generate a risk to the health and safety of workers, especially as concerns vascular, osteoarticular, neurological and muscular ailments.

The Employer is responsible for assessing the risk generated by mechanical vibrations, pursuant to Directive 2002/44/EC.

Operating temperature	-40° - +50° C
Cutting \varnothing and max. unit tensile stress	16 mm - STEEL R=640 N/mm ²



- *It is strictly forbidden to cut sheet metal.*
- *It is strictly forbidden to use the machine for purposes other than those indicated in this installation and maintenance manual.*
- *It is forbidden to use the machine in areas subject to the risk of explosion.*

5.5 SAFETY DEVICES

The machine is fitted with a safety device preventing contact with the upper part of the tool as it returns after cutting. It is a protective plastic guard secured to the machine with 2 screws (part 1 in fig. below).



Never tamper with the safety devices.

Chap. 6 ROUTINE MAINTENANCE



1. *All maintenance, inspection and cleaning operations must be performed with the power supply disconnected and the machine cool (see the person responsible in the maintenance schedule);*
2. *Maintenance operations must be performed in a suitable place according to current safety regulations;*
3. *Carefully clean the machine before starting maintenance work (see paragraph 8.01);*
4. *Wear suitable personal protective equipment while performing maintenance work.*



AFTER MAINTENANCE WORK, MAKE SURE THE GUARDS ARE PUT BACK INTO THEIR CORRECT PLACE.

Periodic maintenance schedule

Frequency	Operation	Method	Person in charge
EVERY 8 HOURS	•CHECKING THE INTEGRITY OF THE MACHINE	Visual	Operator
/	•CLEANING THE PISTON	Para 6.04.01	Operator
EVERY 1600 HOURS	•CHANGING THE OIL	Para 6.01	Maintenance person
EVERY 8 HOURS	•CHECKING THE TIGHTNESS OF NUTS AND BOLTS	Para 6.02	Operator
EVERY 8 HOURS	•CHECKING THE BLADES FOR WEAR	Para 6.03	Operator
/	•REPLACING BLADES		Maintenance person



In case of doubts during the maintenance interventions, to order spare parts or for complex maintenance work, contact your authorised retailer.

6.01 CHANGING AND TOPPING UP THE OIL

The oil change or top up must be performed so as to prevent impurities from contaminating the oil or entering the tank. Impurities in the oil can irreversibly damage the hydraulic parts.



**ALWAYS MAKE SURE THE OIL CONTAINS NO IMPURITIES.
DO NOT USE DIRTY TOOLS.
DO NOT WORK IN DUSTY AREAS.**

CHANGING THE OIL:



**USING A SUITABLE DISPENSER, PREPARE THE CORRECT QUANTITY OF OIL (0.3 l) TO POUR INTO THE TANK.
LEAKING OIL CAN CAUSE SHORT CIRCUITS, FIRE AND EXPLOSIONS.**

1. Place the machine horizontally in a stable position on a work surface with the magnetic cap facing upwards. Place a basin under the machine to catch any oil leaks;
2. Unscrew the magnetic cap (see part 8 in para 3.01) and remove any residues with the piston in its retracted position;
3. Totally drain the oil tank using a suitable extraction system (used oil extraction pump) so that no oil can leak into the machine;
4. Slowly pour in the correct quantity of oil (0.3 l) using suitable equipment (e.g. a funnel). Only use new or clean recommended oil (as indicated on the next page);
5. Fill up to the upper rim of the hole;
6. Put back the oil cap and tighten slightly;
7. Perform some piston strokes to vent the large air bubbles;
8. Move the piston to its maximum extension and rapidly start and stop the motor several times (before the piston automatically retracts);
9. Complete filling;
10. Put the oil cap on and tighten.

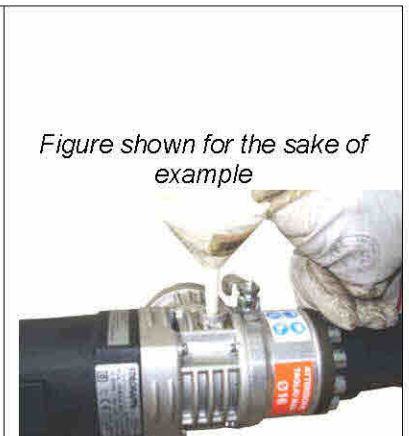

Figure shown for the sake of example

Fig. 4

TOPPING UP THE OIL:



Before unscrewing the magnetic cap to check the oil level, make sure the piston is fully extended and, if necessary, pull it out. If this is not done the oil may leak, air bubbles may form and/or the oil level may be incorrectly measured, thus causing the machine to operate incorrectly.

Only after completing the above operations, proceed as shown below:

1. Place the machine horizontally in a stable position on a work surface with the filling hole facing upwards. Place a basin under the machine to catch any oil leaks;
2. Unscrew the magnetic cap (see part 9 in para 3.01) and remove any residues;
3. Check the amount of missing oil;
4. Slowly top up to the upper rim of the hole with recommended new and clean oil using suitable equipment (e.g.: a funnel as indicated in fig. 4);
5. Put the oil cap on and tighten.

Maximum quantity: 0.3 l.
Type of hydraulic oil: ESSO NUTO H46 or
approved equivalents HLP46
according to DIN 51 524 MIL-H 17672 C



When demolishing the machine or parts of it (oil, plastic, etc.) observe the regulations in force in the country in which this operation is performed.

6.02 CHECKING SCREWS

Periodically, or every day in the event of frequent or prolonged work, make sure that all the screws are perfectly tight.



FAILURE TO TIGHTEN LOCKING SCREWS CAN CAUSE SERIOUS DAMAGE.

6.03 CHECKING BLADES

The use of worn blades decreases the potential of the machine and can needlessly overheat the motor.

REPLACE AS SOON AS YOU NOTICE THEY ARE WORN.

REPLACING BLADES:

Place the machine horizontally on a stable work surface and manually remove the blades after loosening the two lock screws (A) indicated in fig. 5.

If the blades cannot be removed manually, proceed as follows:

1. Loosen the two lock screws (B) in fig. 6 and remove the protective sleeve;
2. Loosen the lateral screws (1) in fig. 7 securing the spring of the upper head;
3. Remove the head drive cam (2) in fig. 8;
4. Remove the nut and washer (6) and pull out the pin (3) in fig. 9;
5. Remove the upper part of the head (4) in fig. 9;
6. Remove the blade with the help of a pin, as shown in fig. 10;
7. If the blades are still in good condition, turn them 120° or mount new blades. Before mounting the blades clean them and the guides;
8. Assembly by inserting the blades as indicated in fig. 12: the short blade in the seat of the upper mobile head with the short screw, the long blade in the seat of the lower fixed head with the long screw;

Attention: position the notch (7) as indicated in fig. 12, mount the blade with the help of a copper or aluminum hammer.

9. When assembling, make sure the head drive cam (2) is inserted in the right position (see fig. 11);
10. Secure the nut with washer (6) so that the upper head can move freely up and down and vice-versa;
11. Secure the two screws on the piston (1) with a screw safety system (thread locker);
12. Put back the guard.

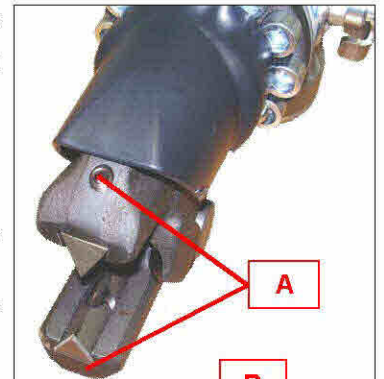

Fig. 5

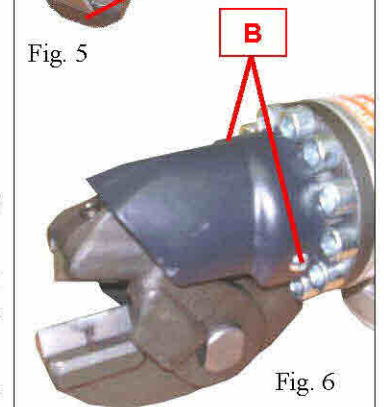

Fig. 6

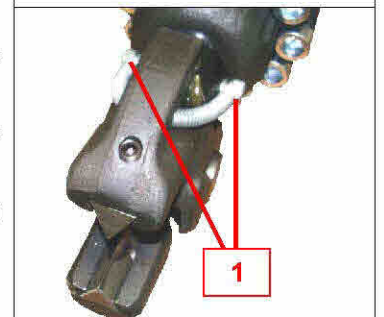

Fig. 7

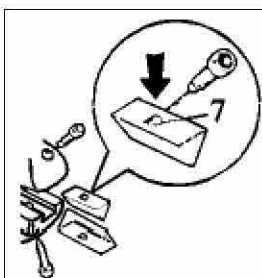

Fig. 12

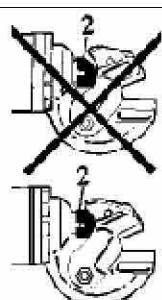

Fig. 11



Fig. 10

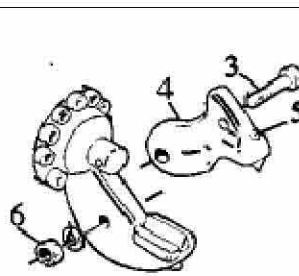

Fig. 9

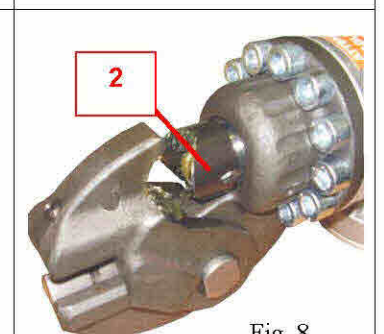

Fig. 8

6.04 HYDRAULIC COMPONENTS

6.04.01 CLEANING THE PISTON



KEEP THE PISTON BODY CLEAN IN ORDER TO ENSURE THE PISTON FULLY RETURNS AT END OF ITS STROKE AS OTHERWISE A NEW STROKE WOULD NOT BE POSSIBLE

In case of operating faults caused by dirt building up on the piston head, proceed as follows (fig. 13):

- Place the machine horizontally on a stable work surface;
- remove the guard by loosening the two screws to the sides
- return the piston B to its home position using a lever
- clean the piston head A

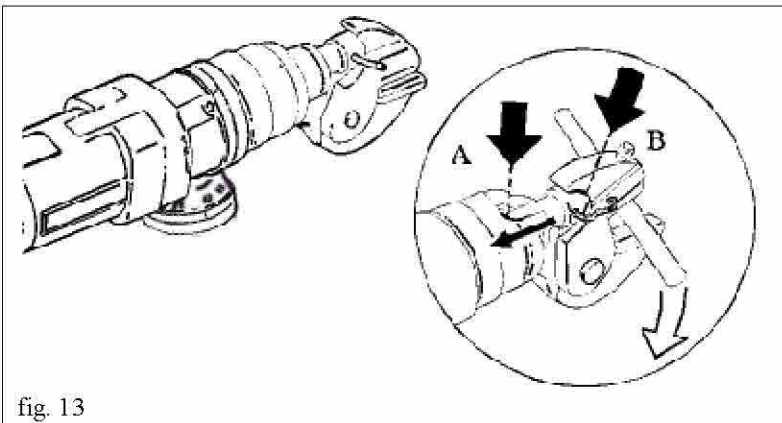

fig. 13

6.04.02 ADJUSTING THE STROKE OF THE UPPER BLADE

(refer to the figures in Para 6.03)

To increase the stroke of the upper blade, move the adjustment screw located under the head drive cam (pos.2 fig.8) as indicated below:

- Move the piston fully back to its home position.
- Place the machine horizontally on a stable work surface.
- Loosen the two lock screws (B) in fig. 6 and remove the protective sleeve.
- Remove the two lateral screws securing the spring of the upper head to access the cam (fig.7).
- Move the head forwards and remove the cam (fig.8).
- Using a screwdriver, turn the adjustment screw anti-clockwise to increase the stroke, **making sure that the piston does not turn on itself.**
- **Make very small adjustments to prevent the blades from overlapping and jamming.**
- Mount the cam and secure the screws with the spring taking care not to overtighten them.
- Put back the guard.

When assembling, make sure the cam is mounted in the correct position as shown in figure 11.

6.04.03 MANUAL RETURN VALVE DOES NOT CLOSE

If the piston is unable to perform another stroke make sure the manual return lever is closed.

6.04.04 MAX. PRESSURE VALVE INCORRECTLY ADJUSTED

In case of a pressure drop for a reason that cannot be directly identified, have a maintenance person or the maker check the maximum pressure valve is clean and calibrated.

6.05 MAIN CHECKS ON THE MOTOR

- Keep the surfaces of the motor clean
- Keep the motor cooling slits clean and unobstructed
- Check the brushes for wear: replace with original material

Chap. 7 TROUBLESHOOTING

7.01 GENERAL

Faults can be divided into three sections:

1. faults on the motor
2. faults on the head
3. faults not closely connected with the machine

ALL OPERATIONS MUST BE PERFORMED BY QUALIFIED PEOPLE IN OBSERVANCE OF SAFETY REGULATIONS.

WORK ON THE MACHINE DURING THE WARRANTY PERIOD MUST BE PERFORMED AT THE MAKER'S FACILITY.

*Remedies marked with the letter R require the assistance of the Authorised dealer.
Remedies marked by the letter M require the intervention of the Maintenance man.
Remedies marked with the letter O can be performed by the Operator.*



7.02 TROUBLESHOOTING THE MOTOR

FAULT	POSSIBLE REASON	POSSIBLE REMEDY	PERFORMED BY
MOTOR DOES NOT START	Battery broken	Replace	O
	Motor	Replace	R
	Switch	Replace	R

FAULT	POSSIBLE REASON	POSSIBLE REMEDY	PERFORMED BY
ELECTRIC MOTOR OVERHEATED	Internal faults	Replace	R
	Battery overheated	Wait for it to cool down	O
	Windings dirty	Clean	M
	Ventilation slits obstructed	Clean	O
	Fan broken	Replace	R
	Motor supports worn	Replace	R
	Mechanical faults on the head	Overhaul	R
	Manifold worn	Replace	R
	Brushes worn	Replace	R

7.03 TROUBLESHOOTING THE HYDRAULIC COMPONENTS

FAULT	POSSIBLE REASON	POSSIBLE REMEDY	PERFORMED BY
OUTWARD STROKE DOES NOT BEGIN	Return stroke incomplete	Push back the piston	O
	Return spring broken	Replace	O
	Max. pressure valve dirty	Consult the Maker	/
	Manual return valve dirty	Clean	O
	Manual return valve faulty	Repair	M
	Oil tank empty	Fill	O
	Valve remains open due to built-up dirt	Clean	O
MOTOR DOES NOT STOP	Earth cable interrupted	Repair	M
	Earth cable rusted	Clean	O

FAULT	POSSIBLE REASON	POSSIBLE REMEDY	PERFORMED BY
OUTWARD STROKE INCOMPLETE	No oil	Top up	O
OUTWARD STROKE DISCONTINUOUS	Air bubbles in the hydraulic circuit	Vent	O
	Max. pressure valve open due to built-up dirt	Consult the Maker	/
	Pump faulty or dirty	Replace	M
	Piston gasket faulty	Replace	M
	Pump O-ring	Replace	M
RETURN STROKE INCOMPLETE	Dirt between piston rod and tool	Move the piston to its end-of-stroke position and clean	O
	Return spring broken	Replace	O
NO FORCE	Oil hydraulic pump faulty	Replace	M
	Dirt on oil hydraulic pump valve	Replace	M
	Max. pressure valve open	Replace	M
	Piston gasket worn	Replace	M
	Pump O-ring broken	Replace	M
PISTON DOES NOT AUTOMATICALLY REVERSE STROKE	Automatic reverse valve faulty	Replace	M
OIL LEAKS FROM TANK COVER	Membrane faulty	Replace	O

Chap. 8 STORAGE AND RESTARTING

8.01 STORAGE

In case of long periods of inactivity, proceed as follows:

8.01.01 ELECTRIC MOTOR

- Clean all the internal electrical parts (rotor, stator, cooling circuit) with compressed air

DO NOT USE CONDUCTIVE OR FLAMMABLE LIQUIDS TO CLEAN INTERNAL ELECTRICAL PARTS.

- To clean the outside of the machine, if necessary, use a cloth dampened in soapy water and then dry thoroughly.
- Check the following are in good condition:
 - insulation
 - switches

- brushes and manifold
- clean the stator, rotor, cooling circuit and fan with compressed air

8.01.02 CYLINDER AND HYDRAULIC COMPONENTS

Before performing these operations, see the relative instructions in Chap. 6

- Check the hydraulic oil and top up or, if necessary, replace.
- Clean the magnetic cap and check the membrane.
- Check for any oil leaks.
- Tighten the screws.

Store the equipment in a clean and dry place accessible only to authorised personnel.

8.02 RESTARTING

Before performing these operations, see the relative instructions in Chap. 6

- Check the oil tank is full and top up if necessary
- Remove any traces of oil remaining after topping up or applied to protect metal parts from the grip and other parts that can be gripped.

ELECTRIC MOTOR

- Make sure the battery, the battery charger and the machine body are not damaged.
- Commission the machine as described in Chapter 5 of this manual.
- Start the machine a few times and make sure no operating faults occur.

ELIMINATE ANY FAULTS BEFORE STARTING WORK.

Chap. 9 DISPOSAL

When disposing of the machine, the various materials must be separated.

The tool comprises the following groups of materials:

- ferrous materials
- copper
- plastic

Observe current legislation when sorting, storing, recycling or disposing of these materials.

Only for EC countries:



This electric tool is marked with the following recycling symbol. Consistently with Directive 2002/96/EC on waste electrical and electronic equipment (WEEE), at the end of its useful lifetime, this product must be disposed of separately in suitable collection areas and not together with normal domestic waste. A benefit for the environment to help everyone.

Chap. 10 SPARE PARTS AND ACCESSORIES CATALOGUE

10.01 ORDERING INFORMATION

For technical assistance and spare parts, both during and after the period of warranty, quote the data indicated on the ID plates and the serial number punched on the tool body (fig. 14)

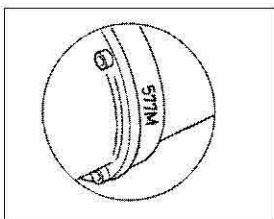

fig. 14

Orders for spare parts must be accompanied by the following information:

1. Type of equipment
2. Serial number
3. Part number and position in exploded drawing
4. Quantity
5. Revision status indicated on the back cover of the manual.

The Manufacturer can only supply the appropriate spare part if the required data is complete, since subsequent improvements may have entailed structural variations to the equipment and therefore to the spare parts.

Cordless cutter MU16 - ELECTRIC PART - assy P/N 150.02748

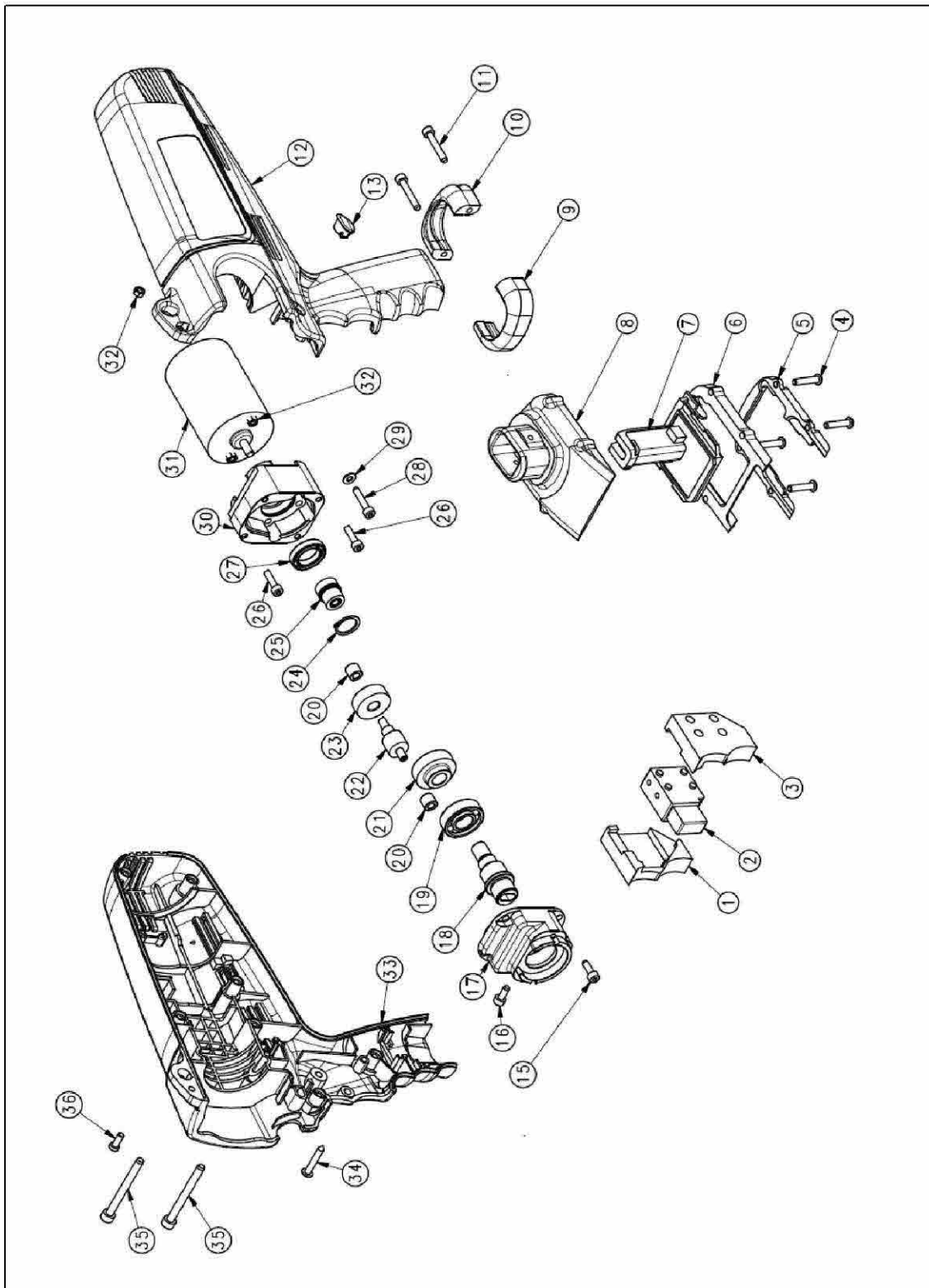

Cordless cutter MU16 - ELECTRIC PART - assy P/N 150.02748

#	P/N	Rev.	Item	Q.ty
1	1.10.5327	2	SWITCH HOUSING RIGHT	1
2	1.40.020	1	SWITHC	1
3	1.10.5326	1	SWITCH HOUSING LEFT	1
4	1.60.1228	0	SCREW	4
5	1.10.6864	5	LOWER SLIDE BATTERY HOUSING	1
6	1.10.6861	4	UPPER SLIDE BATTERY HOUSING	1
7	1.40.597	0	ELECTRONIC BOARD	1
8	1.10.6860	3	BATTETY HOOKING	1
9	1.10.7019	3	FRONT HALF-WASHER	1
10	1.10.7018	3	REAR HALF-WASHER	1
11	1 60 793	0	SCREW	2
12	1.10.7190	0	LEFT HALF-SHELL	1
13	1.30.342	0	CUP	1
15	1 60 498	0	SCREW	4
16	1.60.107	1	SCREW	1
17	1.10.4467	7	UPPER SHELL GREAR BOX	1
18	1.10.4421	4	TRANSMISSION SHAFT	1
19	1.60.082	0	BEARING	1
20	1.10.980	2	BUSHING	2
21	1.10.973	2	TOOTHED CROWN	1
22	1.10.974	2	TOOTHED PINION	1
23	1.10.977	3	TOOTHED CROWN	1
24	1.60.396	0	CIRCLIP	1
25	1.10.5008	0	PINION	1
26	1.60.141	1	SCREW	2
27	1.60.3043	0	BEARING	1
28	1 60 729	0	SCREW	2
29	1 60 319	0	WASHER	2
30	1.10.4466	7	LOWER SHELL GREAR BOX	1
31	1.40.909	0	ELETTRIC MOTOR	1
32	1.60.207	0	NUT	3
33	1.10.7191	0	RIGHT HALF-SHELL	1
34	1.70.025	1	SCREW	7
35	1 60 2019	0	SCREW	2
36	1.60.753	0	SCREW	1

EXPLODED VIEW – MU16 BATTERY CUTTER P/N 150.02752
Cordless MU16 – Hydraulic parts – assy P/N 150.02549

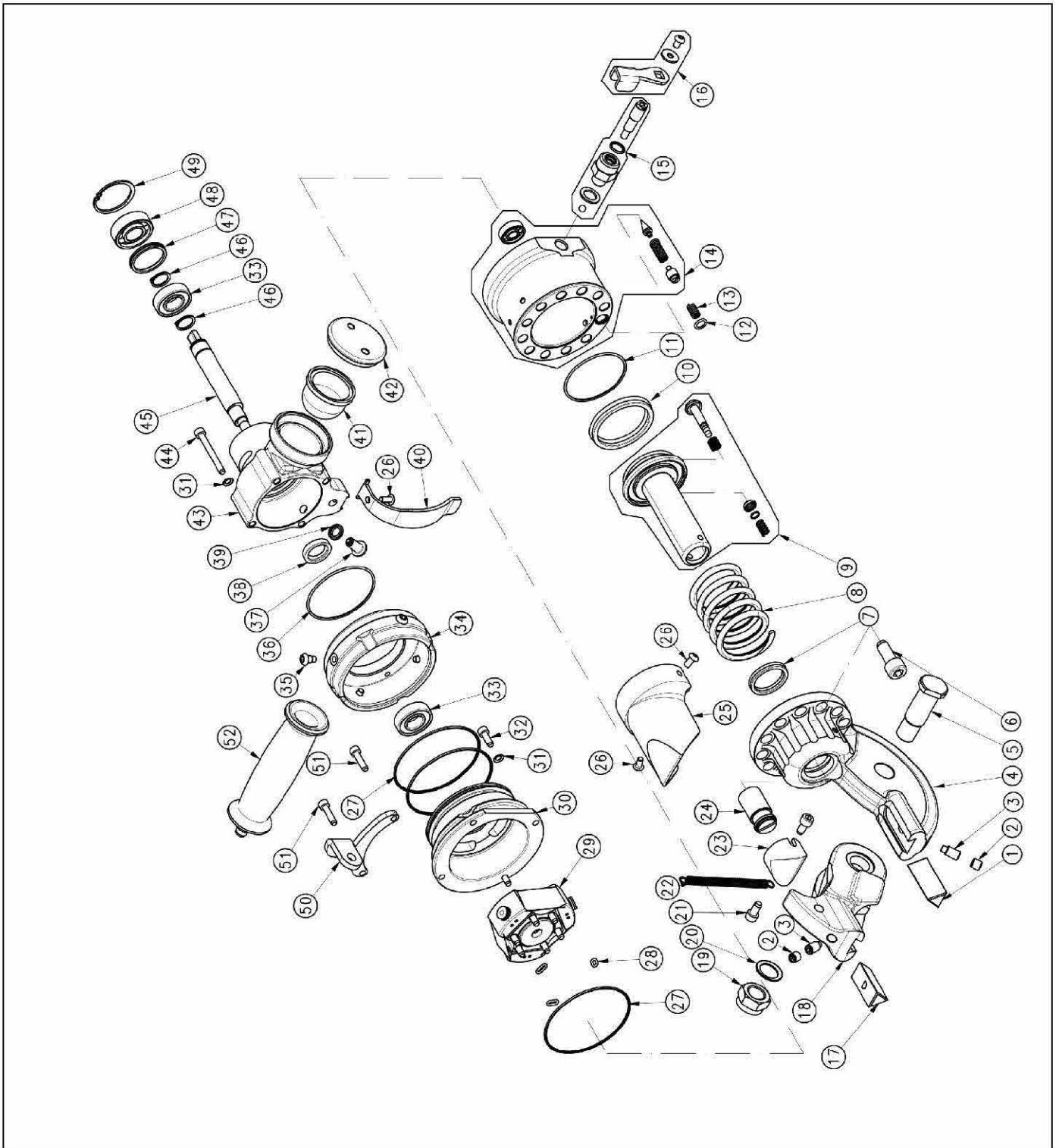

EXPLODED VIEW – MU16 BATTERY CUTTER P/N 150.02752
Cordless MU16 – Hydraulic parts – assy P/N 150.02549

#	P/N	Rev.	Item	Q.ty
1	1.10.233	2	LOWER BLADE	1
2	1.60.829	1	SCREW	2
3	1.60.2056	0	SCREW	2
4	1.10.3557	6	HEAD HOLDER BLADE	1
5	1.10.3559	2	PIN	1
6	1 60 112	0	SCREW	11
7	1.30.070	0	GASKET	1
8	1.10.231	0	RETURN PISTON SPRING	1
9	1.50.619	0	PISTON	1
10	1.30.032	0	GASKET	1
11	1.30.045	2	O-RING	1
12	1.30.225	2	O-RING	1
13	1.10.248	1	SPRING	1
14	1.50.1942	0	CYLINDER	1
15	1.50.1932	0	RELEASE VALVE (VALVE GROUP)	1
16	1.50.1933	1	RELEASE VALVE (LEVER GROUP)	1
17	1.10.269	2	UPPER BLADE	1
18	1.10.3558	5	MOBILE HEAD	1
19	1.60.201	0	NUT	1
20	1.60.900	0	WASHER	1
21	1 60 3013	0	SCREW	2
22	1.10.230	0	SPRING	1
23	1.10.624	2	PUSHING CAM	1
24	1.10.579	1	ADJUSTMENT SCREW	1
25	1.30.546	1	SAFETY COVER	1
26	1.60.937	1	SCREW	3
27	1.30.046	2	O-RING	3
28	1.30.017	2	O-RING	3
29	1.50.511	0	PUMP (ASSY)	1
30	1.10.6809	4	ROTATION SUPPORT	1
31	1.60.410	0	WASHER	6
32	1.60.3094	0	SCREW	2
33	1.60.079	0	BEARING	2
34	1.10.6815	2	EXTERNAL RING FOR ROTATION	1
35	1.10.6818	0	SCREW	4
36	1.30.425	0	O-RING	1
37	1.50.923	2	MAGNETIC CUP	1
38	1.60.083	0	OIL SEAL	1
39	1.60.3046	0	BONDED SEAL	1
40	1.10.4962	4	SWITCH PROTECTION	1
41	1.30.296	0	MEMBRANE	1
42	1.10.1871	0	MEMBRANE CUP	1
43	1.10.4423	4	OIL TANK	1
44	1 60 811	0	SCREW	4
45	1.10.6813	0	ECCENTRIC SHAFT	1
46	1.60.396	0	CIRCLIP	2
47	1.10.4625	1	THICKNESS	1
48	1.60.3039	0	BEARING	1
49	1.60.3045	2	CIRCLIP	1
50	1.10.6817	1	HANDLE SUPPORT	1
51	1.60.105	0	SCREW	2
52	1.50.618	2	GRIP	1

Chap. 11 DECLARATION OF CONFORMITY

<p>EDILGRAPPA S.r.l. Machines and equipment for the building trade, industry and rescue.</p> <p>Via Callesello, 4 – 31030 BORSO DEL GRAPPA (TV) Tel. (+39) 0423 910122 r.a. – Fax (+39) 0423 542122 cut@edilgrappa.com www.edilgrappa.com</p>	<p>DECLARATION OF CONFORMITY</p>	
-------------------------------------------------------------------------------------------------------------------------------------------------------------------------------------------------------------------------------------------------------------------------------------------------------------------------------------------------------------	-----------------------------------------	-------------------------------------------------------------------------------------

Maker: **EDILGRAPPA srl**
Machines and equipment for the building trade, industry and rescue
Via Callesello, 4
31030 Borso Del Grappa (TV)

Name and address of person authorised to draw up the technical brief:
Giacomo Rorato
Via Callesello, 4
31030 Borso Del Grappa (TV)

General name: Cordless shear
Function: cutting metal rod \varnothing max 16 mm
Type: Cordless shear with adjustable head
Model: **MU 16**
Trade name: **CORDLESS SHEAR MU16 18V Li-Ion WITH ADJUSTABLE HEAD**

Serial n°: _____

Year of construction: _____

DECLARES THAT THE ABOVE-MENTIONED EQUIPMENT IS COMPLIANT WITH THE FOLLOWING DIRECTIVES:

Machinery Directive	2006/42/EC (Proc. Annex VIII)
EMC Directive	2004/108/EC
Low Voltage Directive	2006/95/EC
RoHS Directive	2011/65/EC
WEEE Directive	2002/96/EC

Place: Borso Del Grappa TV

Date: _____

Signature

PAOLO MAZZARO
(Legal representative)

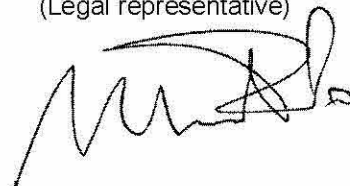

EDILGRAPPA Srl
**MACHINES AND EQUIPMENT FOR THE BUILDING TRADE, INDUSTRY
AND RESCUE**

31030 BORSO DEL GRAPPA (TV) - ITALY - Via Callesello, 4
Tel. 0423 910122 – Fax 0423 542122

E-mail: cut@edilgrappa.com <http://www.edilgrappa.com>